

Ongoing List of Topics:

- URL: <http://www.ece.mtu.edu/faculty/bamork/EE5223/index.htm>
- Term Project - next: short literature search and TOC/outline

Today:

- Short circuit protection in grid systems
 - Directional overcurrent
 - Impedance
- Basic connections of directional overcurrent (67) relays.
 - Phase relays - each line current is polarized with V_{LL} from other phases.
 - Ground relay - residual current ($3I_{a0}$) polarized with $V_{\text{broken delta}}$ ($3V_{a0}$)
- Excellent Illustrations: figures 3.7 thru 3.10
- Symmetrical Components overview
 - Fault contributions, thevenin sources as fault source
 - transformer connections in zero seq, and phase shifts in pos/neg.
 - Sequence networks for 2- and 3-winding transformers.
- Overview of many types of protection
 - Distance relaying for lines, bus diff, xfmr diff, synch check, capacitor banks, generators, motors, etc. (take a quick run through chapters of text, also Glover & Sarma, Ch.10).

67 Relay:

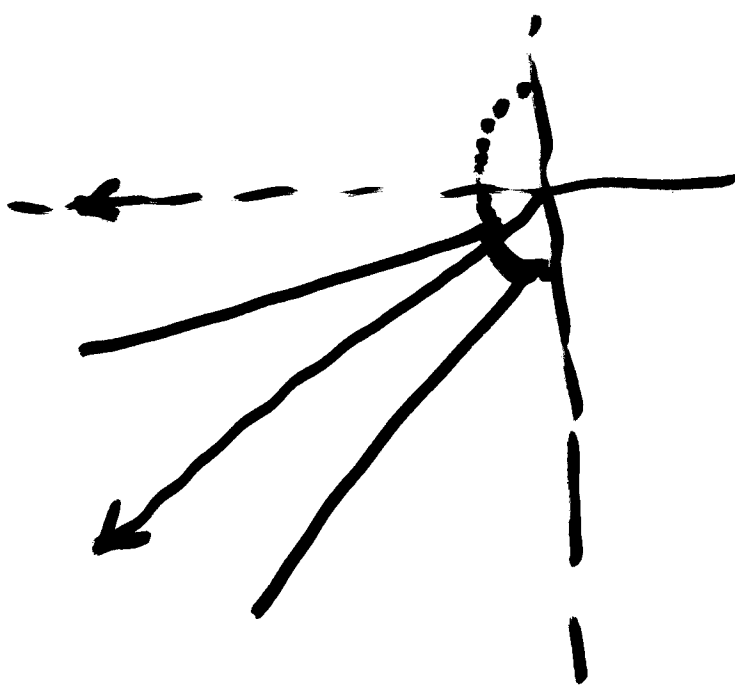
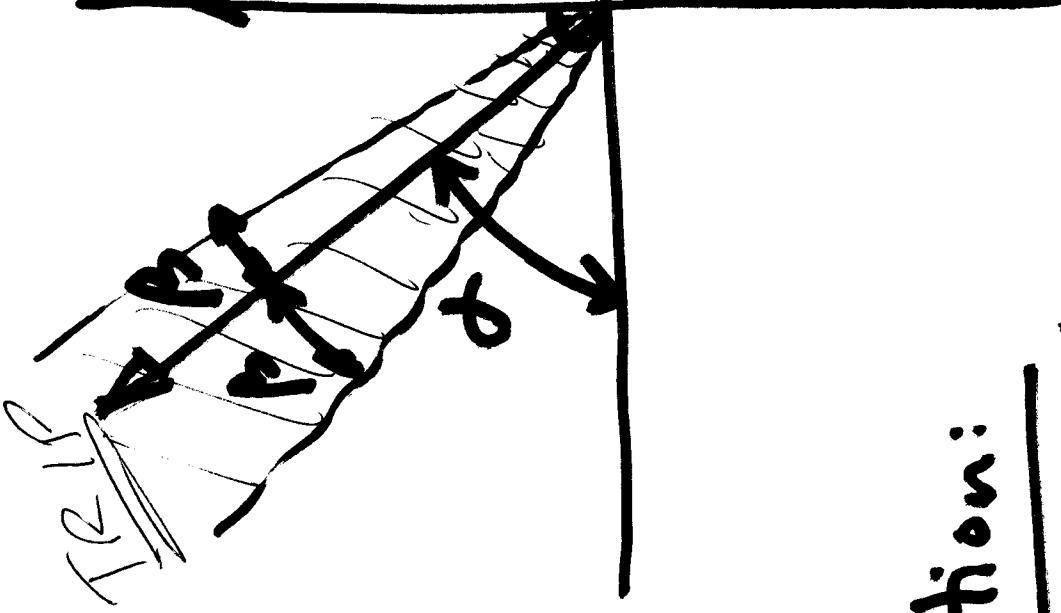
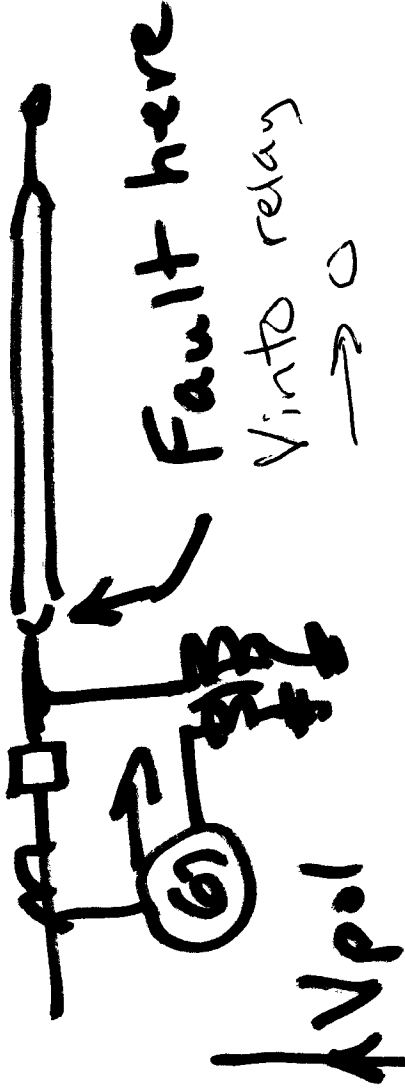

Solution:

- "Memory" feature
- Holds angle of last-known V_{p01} .

Voltage Measurement from CCVT

"Subsidence"
Transient"

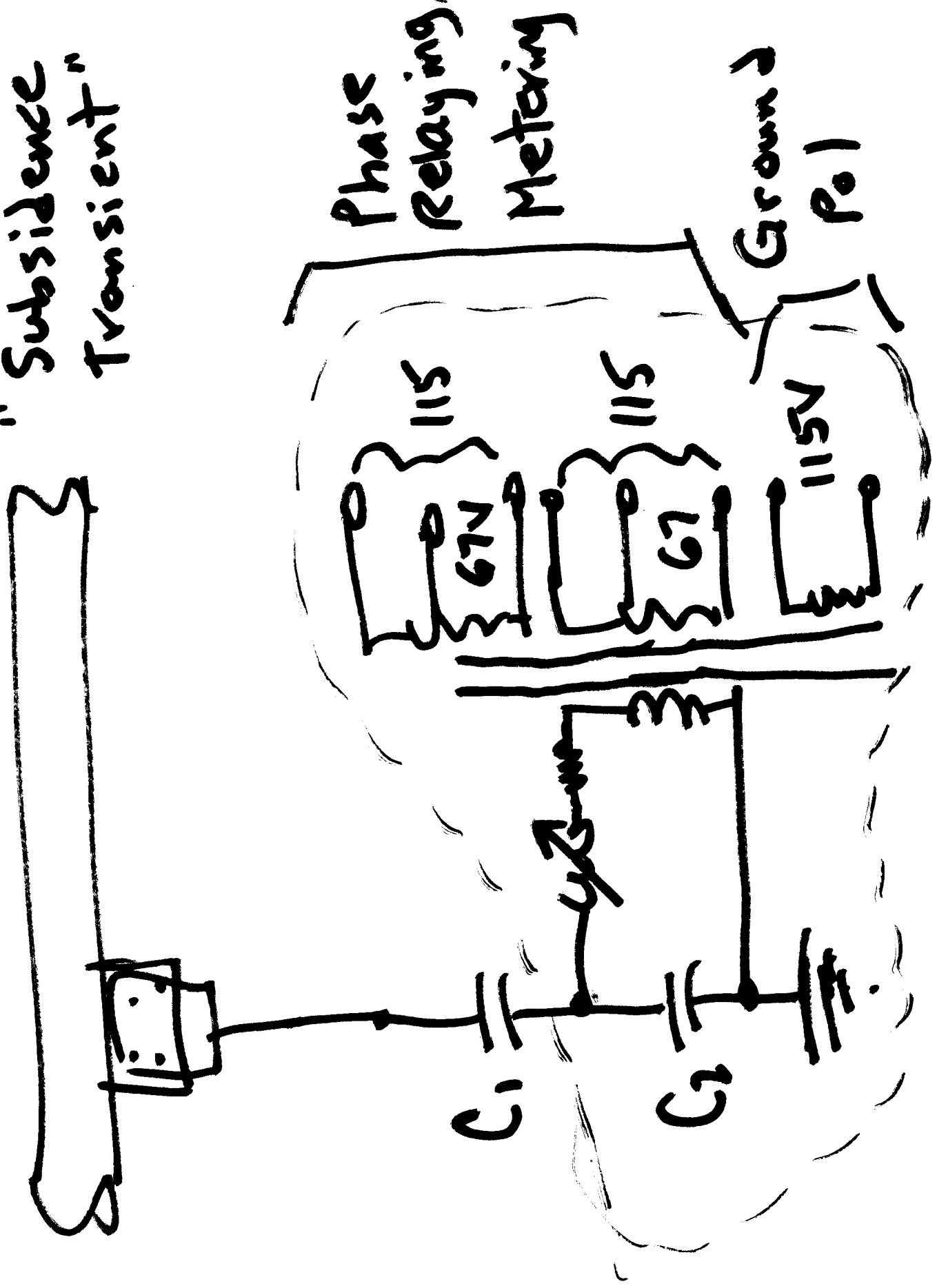

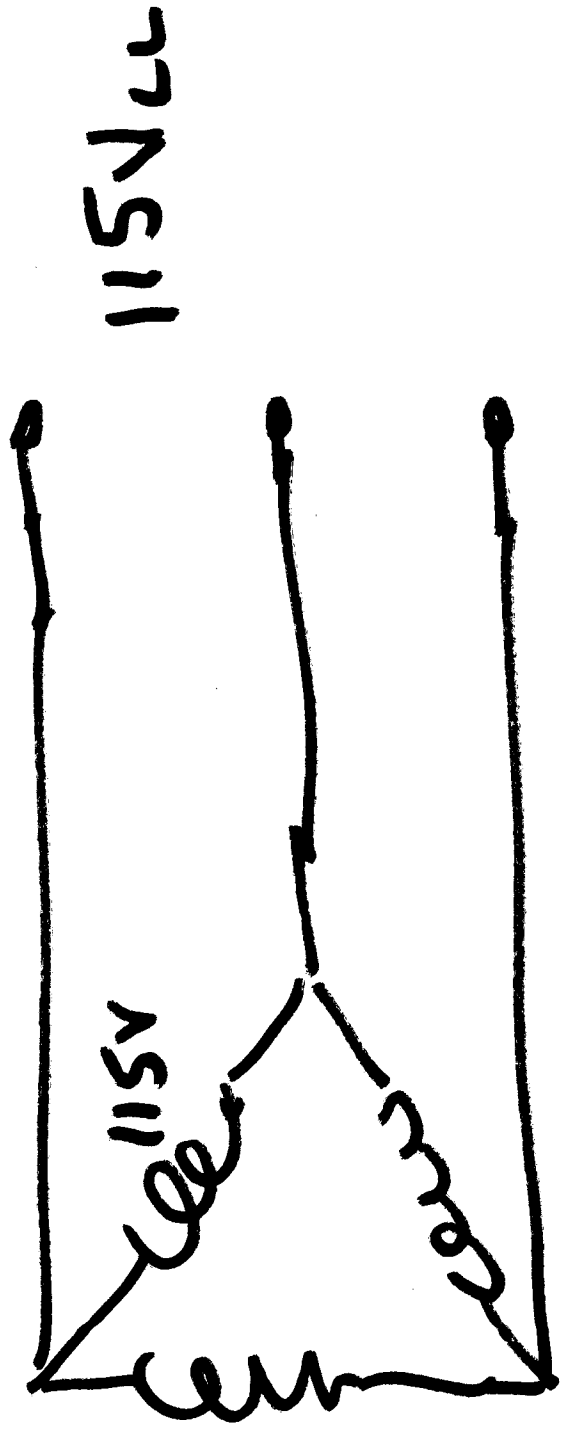
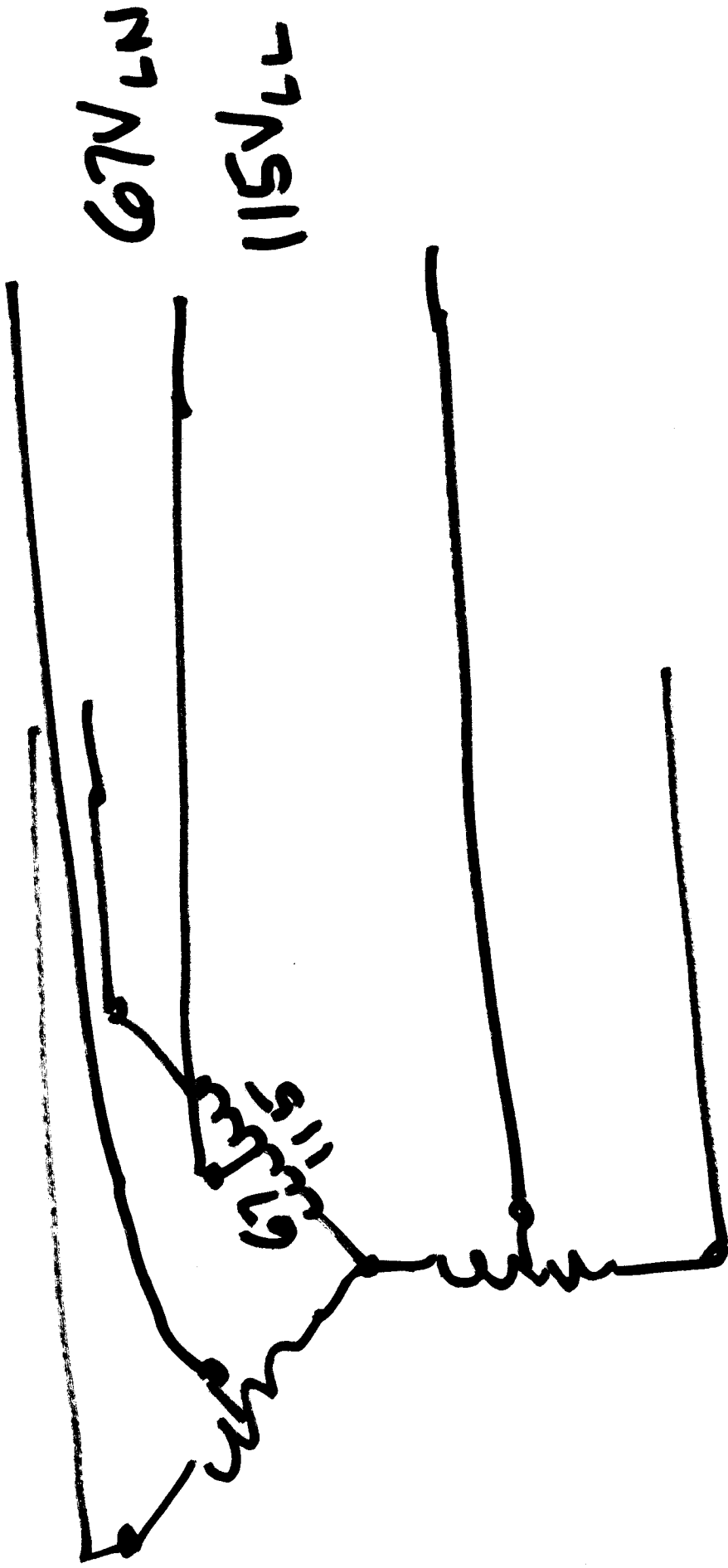

Grund Polarisation

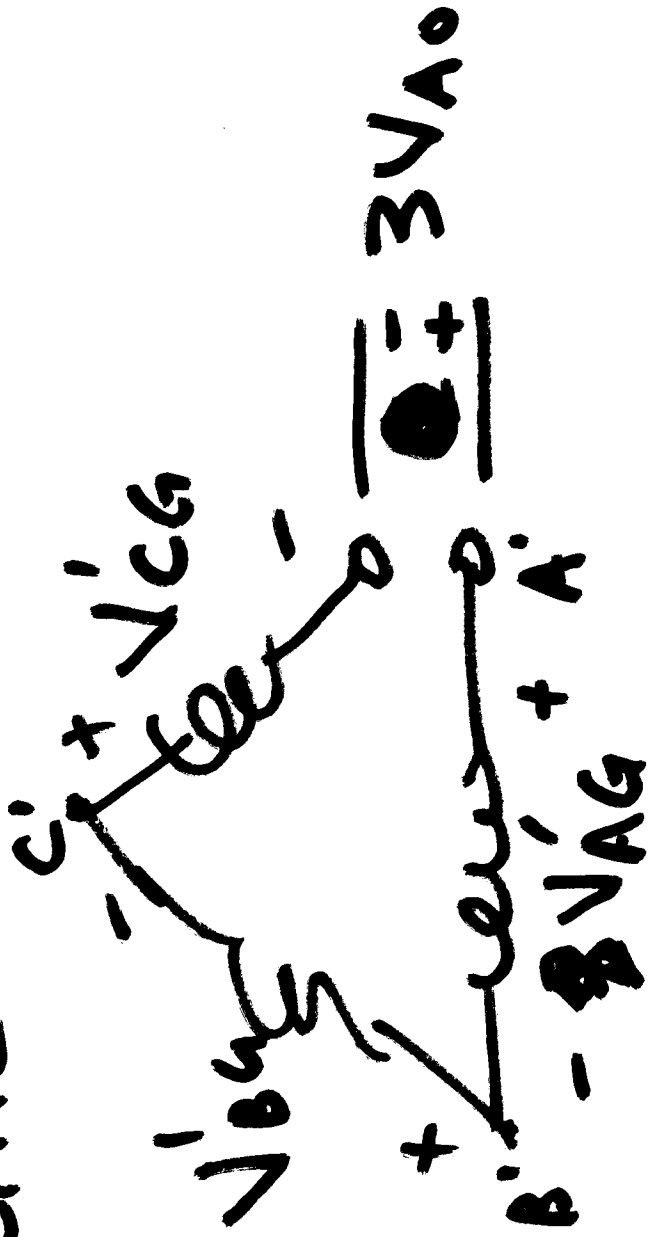

$$3V_{AO} = V_{AG}' + V_{BG}' + V_{CG}'$$

Close-in fault, LG at peak voltage

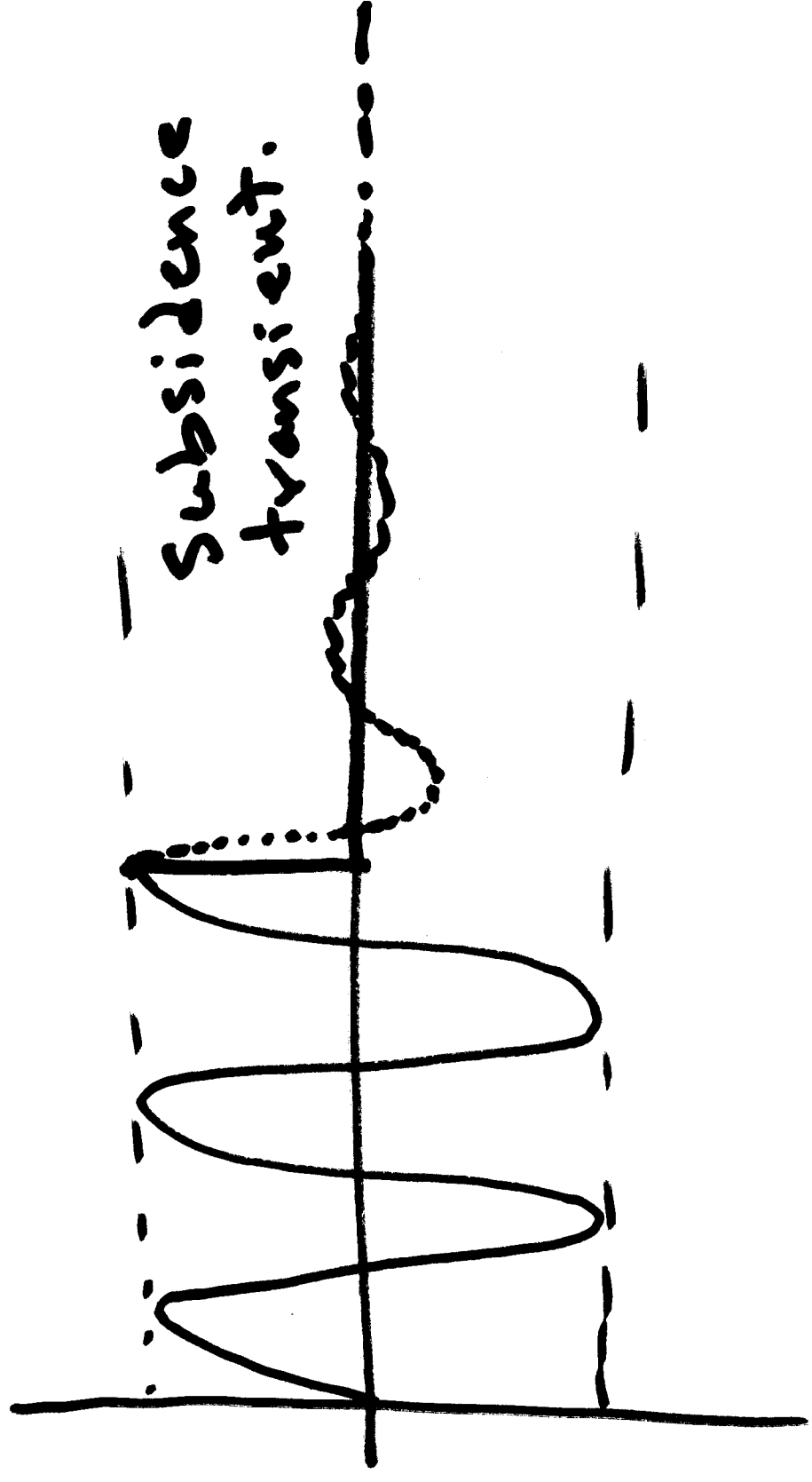

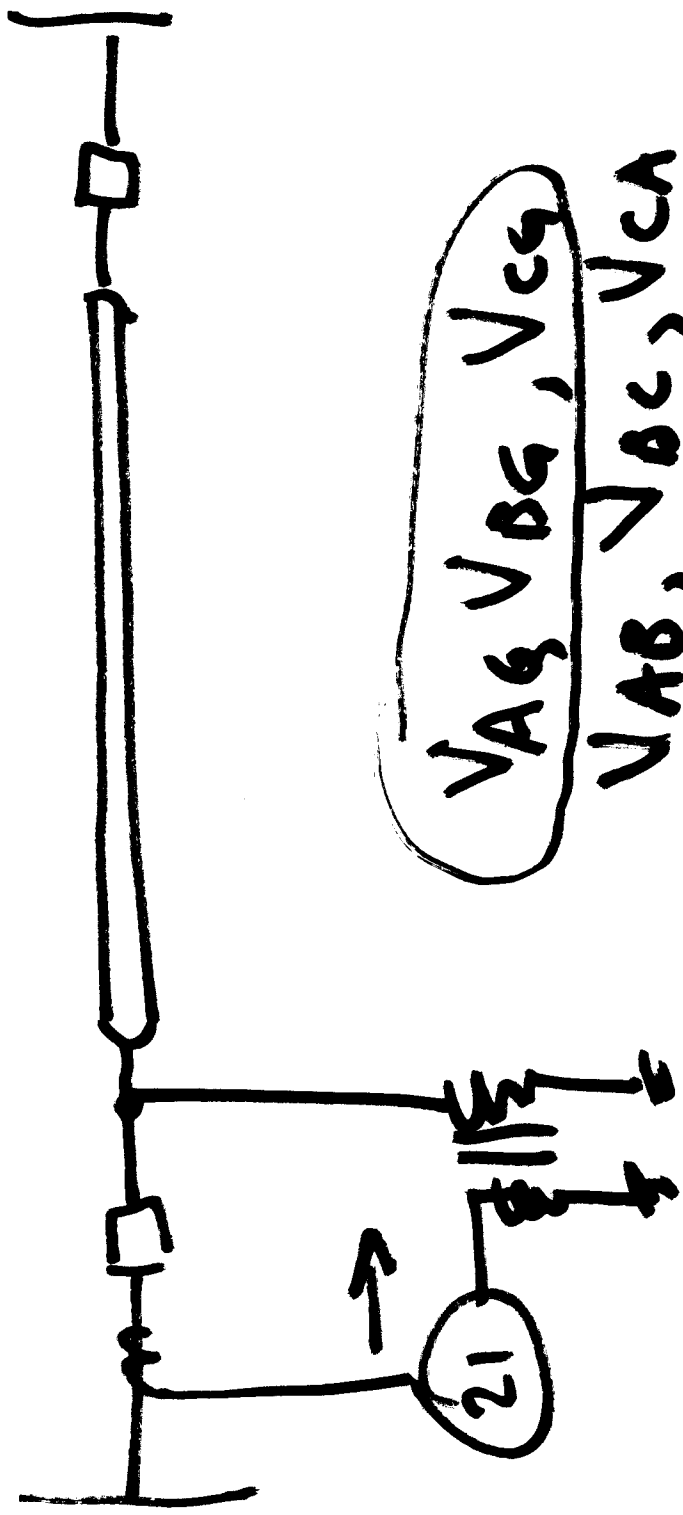

V_{AG}, V_{BG}, V_{CG}

V_{AB}, V_{BC}, V_{CA}

V_{A0}, V_{A1}, V_{A2}

$$\bar{Z} = \frac{V_{\text{relay}}}{I_{\text{relay}}}$$

I_A, I_B, I_C

I_{A0}, I_{B0}, I_{C0}

"Delta Currents": $(I_A - I_B), (I_B - I_C), (I_C - I_A)$

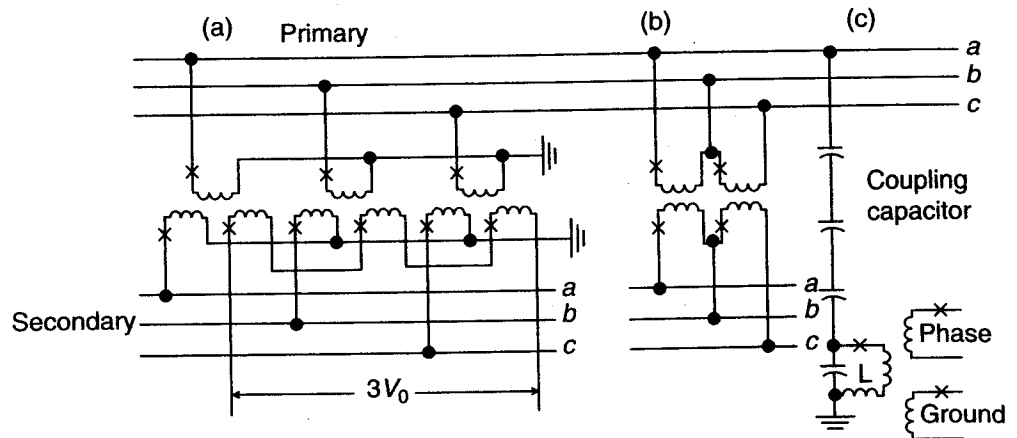

FIGURE 5.18 Typical voltage sources for relays: The secondary circuits for the coupling capacitor voltage transformer (CCVT) device are simplified schematics, for concept only. (a) secondary phase-and-ground voltage with three double secondary VTs connected phase-to-ground; (b) secondary phase voltage with two single secondary VTs connected open delta; (c) secondary phase-and-ground voltage with three CCVTs connected phase-to-ground. [Only one phase shown, *b* and *c* phases duplicate with secondaries connected as in (a).]

Protective relays utilizing voltage are usually connected phase-to-phase, so the transformers are normally rated 120 V line-to-line. Taps may be provided to obtain either 69.3 V or 120 V line-to-neutral. When available, double secondaries provide the means of obtaining zero-sequence voltage for ground relays (see Figure 5.18a). If only a single transformer secondary winding is available, an auxiliary wye ground-broken delta auxiliary VT can be connected to the secondary *a*, *b*, and *c* bus of Figure 5.18a for $3V_0$, similar to the connections shown in Figure 1.10. CCVTs commonly have double secondaries for both phase and $3V_0$ voltages (see Figure 5.18c).

Three VTs or three CCVTs, such as shown in Figure 5.18a and c, pass positive-, negative-, and zero-sequence voltage. The open-delta connection of Figure 5.18b will pass both positive- and negative-sequence voltage, but not zero-sequence voltage.

VTs are used at all power system voltages and are usually connected to the bus. At about 115 kV, the CCVT type becomes applicable and generally more economical than VTs at the higher voltages. Usually, the CCVTs are connected to the line, rather than to the bus, because the coupling capacitor device may also be used as a means of coupling radio frequencies to the line for use in pilot relaying. This is discussed in Chapter 13.

Either type of transformer provides excellent reproduction of primary voltage, both transient and steady-state, for protection functions. Saturation is not a problem because power systems should not be operated above normal voltage, and faults result in a collapse or reduction in voltage. Both have ample capacity

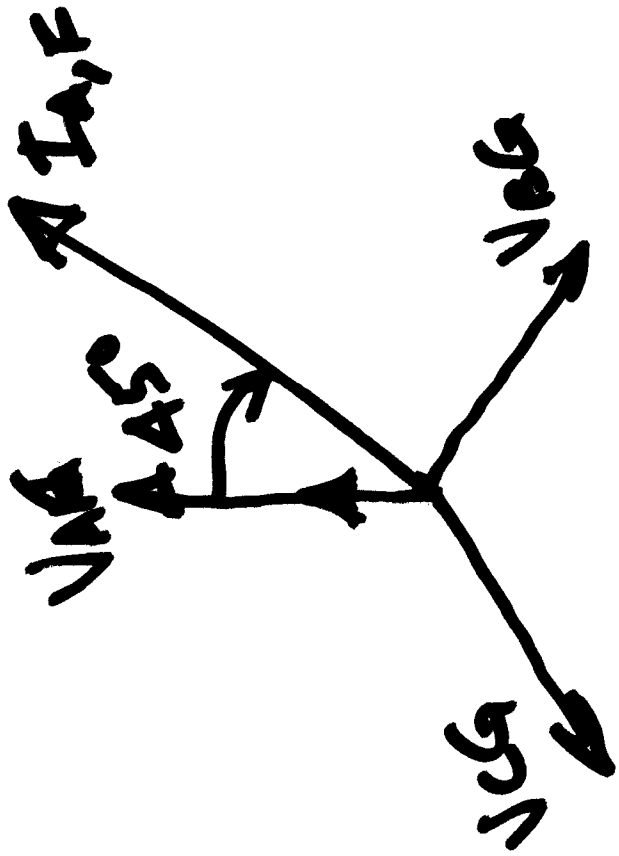

$$\frac{x}{R} = 1$$

$$V_{A0} + V_{B0} + V_{C0} = 3V_0$$

$$= V_{A6} + V_{B6} + V_{C6}$$

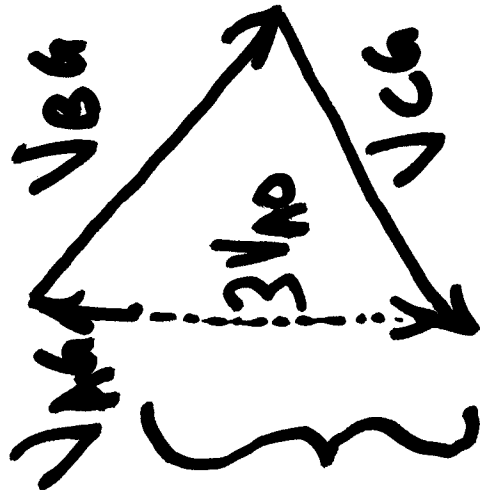

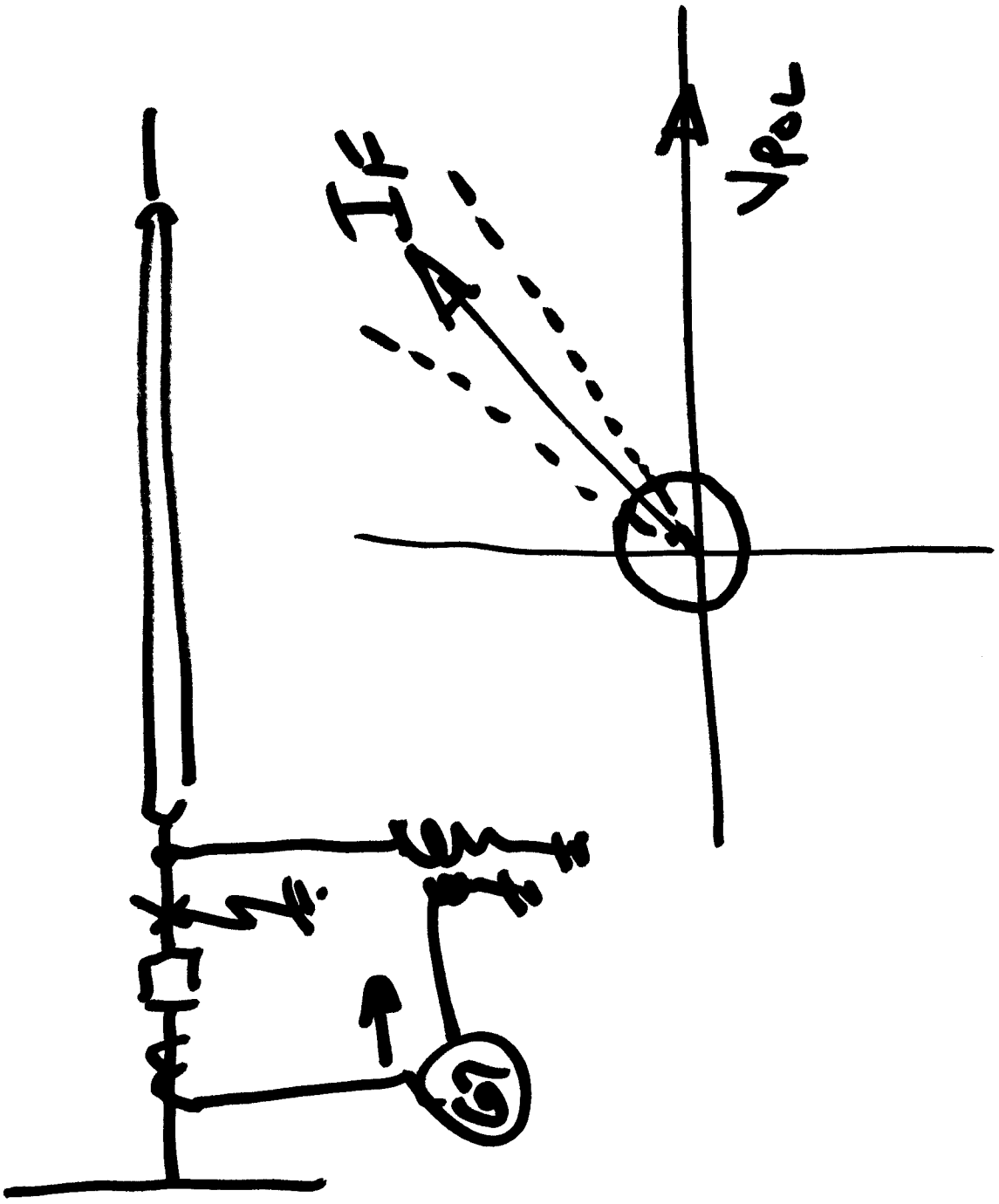

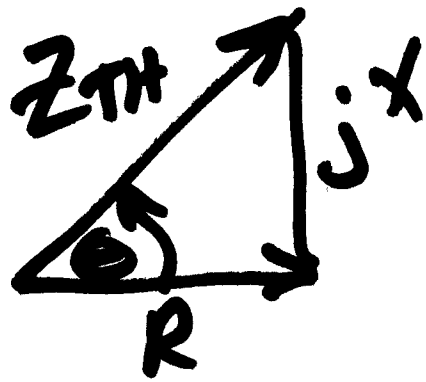
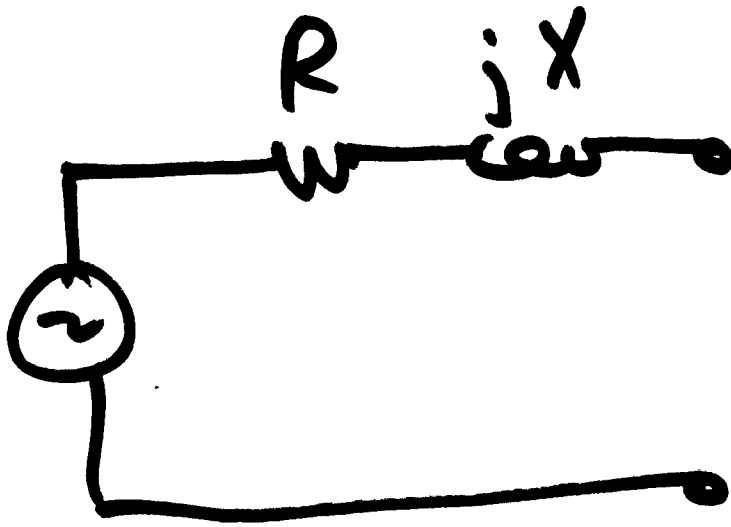

$$\frac{X}{R} = 1 \Rightarrow \theta = 45^\circ$$

$$\frac{X}{R} = 10 \Rightarrow \theta = 84.3^\circ$$

$$\frac{X}{R} = \infty \Rightarrow \theta = 90^\circ$$

$$V_{AG} = V_{A1} + V_{A2} + V_{A0}$$

$$V_{BG} = V_{B1} + V_{B2} + V_{B0}$$

$$V_{CG} = V_{C1} + V_{C2} + V_{C0}$$

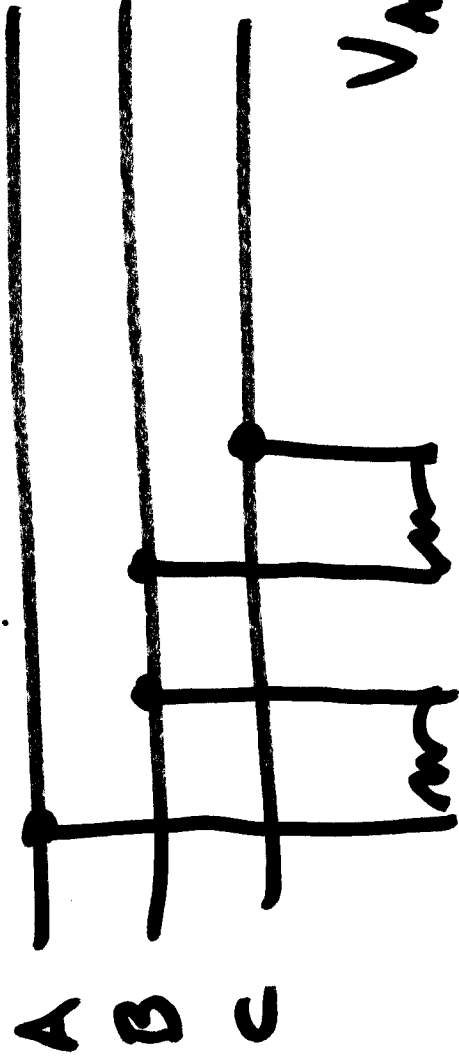

$$V_{AB} = V_{AG} - V_{BG}$$

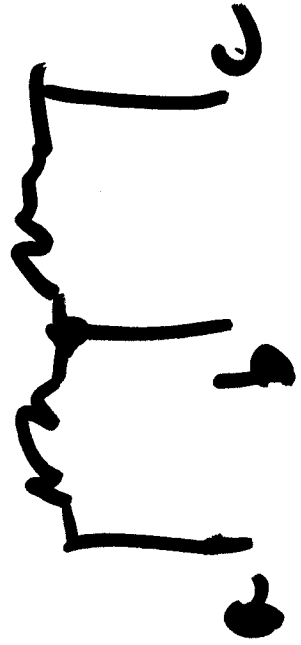

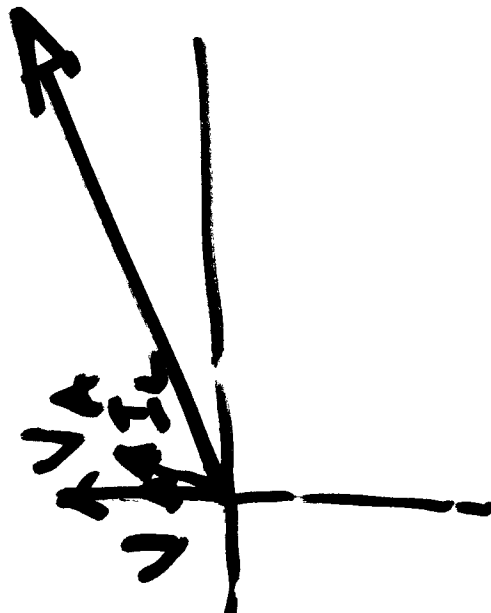
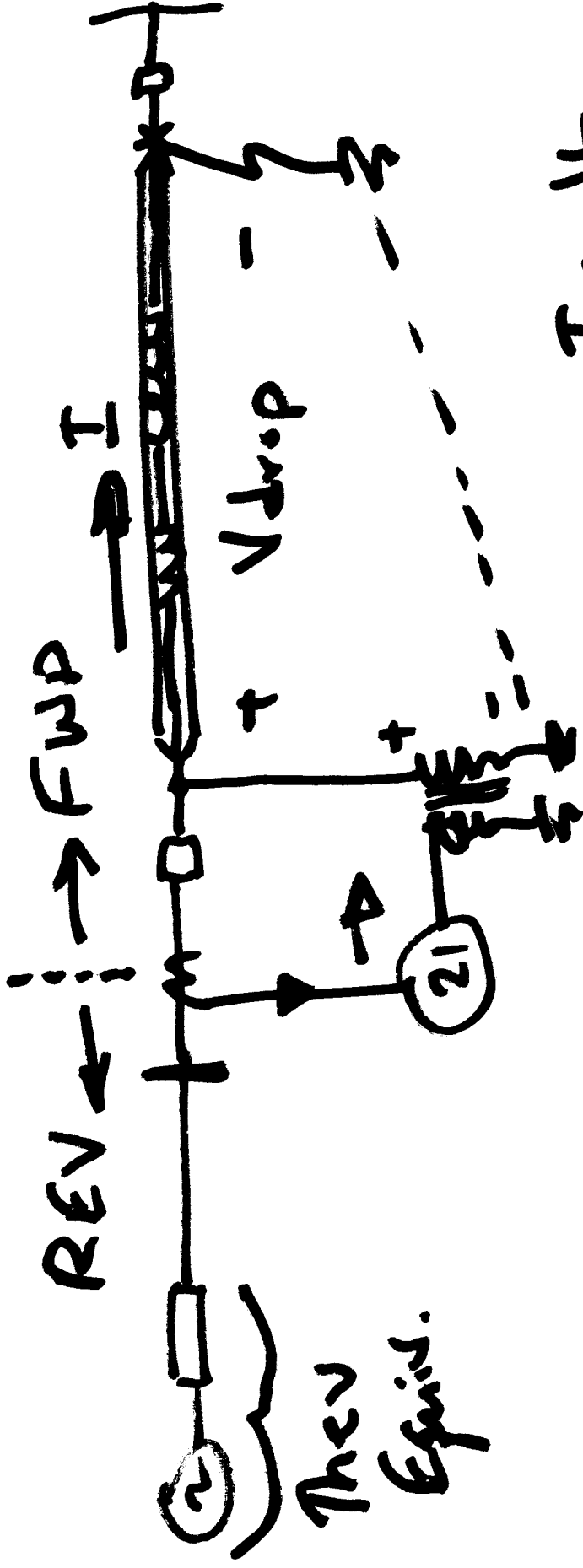

$$Z = \frac{V}{I}$$

Pre-Fault (load)

$\Rightarrow Z$ is big, small angle

Fault $\Rightarrow Z$ gets small, angle gets big (line impedance angle)

