

Ongoing List of Topics:

- URL: <https://pages.mtu.edu/~bamork/EE5223/>
- Term Project - Follow posted Guidelines!
 - Formal outline w/complete references complete, get/keep cranking...
- Homework set for Ch.4 (extra day for Prob 4 if needed)
 - Problems due Tues Apr 4th, 9am. Help video, e-mail forum!
- Protection fundamentals for 87T, cont'd –
 - a) correct connection of CT secondaries to relays (Lecture 29)
 - b) relay settings, to compensate for pri voltage ratio and CT ratios.
 - c) Mismatch problems - due to being forced to use less than full CT ratio, and having Pri and Sec CTs with different accuracy levels.
Differential slope of trip characteristic can be 10%, 15%, 25%, etc, to allow for mismatch. Refer to XFMR.pdf !
- Next: Bus protection - 87B
 - Low Impedance relays
 - High-Impedance relays
 - Partial bus protection using 51 relay (distribution bus w/radial feeders)

From: Grainger-Stevenson
 (EES200 Text) ©1994

TABLE A.1
 Typical range of transformer reactances†
 Power transformers 25,000 kVA and larger

Nominal system voltage, kV	Forced-air-cooled, %	Forced-oil-cooled, %
34.5	5-8	9-14
69	6-10	10-16
115	6-11	10-20
138	6-13	10-22
161	6-14	11-25
230	7-16	12-27
345	8-17	13-28
500	10-20	16-34
700	11-21	19-35

† Percent on rated kilovoltampere base. Typical transformers are now designed for the minimum reactance value shown. Distribution transformers have considerably lower reactance. Resistances of transformers are usually lower than 1%.

OA/FA/FA

OA/FOA/FOA

ONAN/~~ONAN~~
 ONAF/ONAF

X_q	1.66 1.63-1.69	1 1.7
X'_d	0.21 0.18-0.23	0.2
X''_d	0.13 0.11-0.14	0.2
X_2	$= X''_d$	$=$
X_0 §		

† Data furnished by ABB Power T &
 ‡ Reactances of older machines will
 § X_0 varies so critically with armature
 from 0.1 to 0.7 of X''_d .

TABLE A.2
Typical reactances of three-phase synchronous machines†

Values are per unit. For each reactance a range of values is listed below the typical value‡

	Turbine-generators				Salient-pole generators	
	2-pole		4-pole		With dampers	Without dampers
	Conventional cooled	Conductor cooled	Conventional cooled	Conductor cooled		
X_d	1.76 1.7-1.82	1.95 1.72-2.17	1.38 1.21-1.55	1.87 1.6-2.13	1 0.6-1.5	1 0.6-1.5
X_q	1.66 1.63-1.69	1.93 1.71-2.14	1.35 1.17-1.52	1.82 1.56-2.07	0.6 0.4-0.8	0.6 0.4-0.8
X'_d	0.21 0.18-0.23	0.33 0.264-0.387	0.26 0.25-0.27	0.41 0.35-0.467	0.32 0.25-0.5	0.32 0.25-0.5
X''_d	0.13 0.11-0.14	0.28 0.23-0.323	0.19 0.184-0.197	0.29 0.269-0.32	0.2 0.13-0.32	0.30 0.2-0.5
X_2	$= X''_d$	$= X''_d$	$= X''_d$	$= X''_d$	0.2 0.13-0.32	0.40 0.30-0.45
X_0 §						

$X_1 \approx$

†Data furnished by ABB Power T & D Company, Inc.

‡Reactances of older machines will generally be close to minimum values.

§ X_0 varies so critically with armature winding pitch that an average value can hardly be given. Variation is from 0.1 to 0.7 of X''_d .

Forced-oil-cooled, %

- 9-14
- 10-16
- 10-20
- 10-22
- 11-25
- 12-27
- 13-28
- 16-34
- 19-35

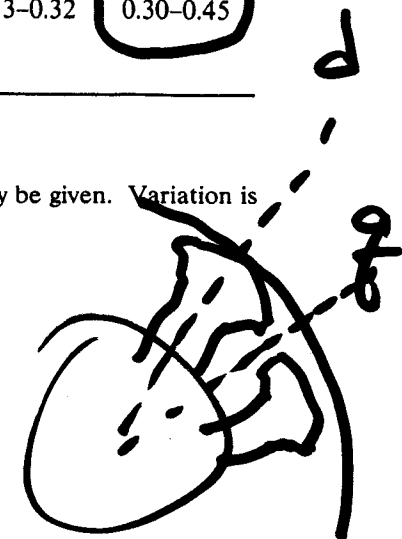

- Aging transformers: 25-40 yr, 40+

- Aging - LOL

- Thru-faults

- Lightning

⇒ Failure Mechanism.

- Grid bottlenecks

- Energy contracts

- System security, contingency

- Time to deliver: 2+ yrs.

- Shipping transport: huge issues.

Waukesha Quality Inside

Means Reliability Is On Your Side

Low no-load losses result from use of laser-scribed, super-grain-oriented steel.

Transformer exterior is coated to a minimum thickness of 3 mils. This coating has superior endurance characteristics and meets the ANSI C57.12.28 standard.

Load Tap Changer is designed to withstand up to a half-million operations without need for contact replacement.

Lamination width customized to achieve a near perfect-circle core cross section, resulting in the most efficient use of materials plus a lighter, more compact high-performance transformer.

Material-stabilized coils are pressure-fit within the core frame.

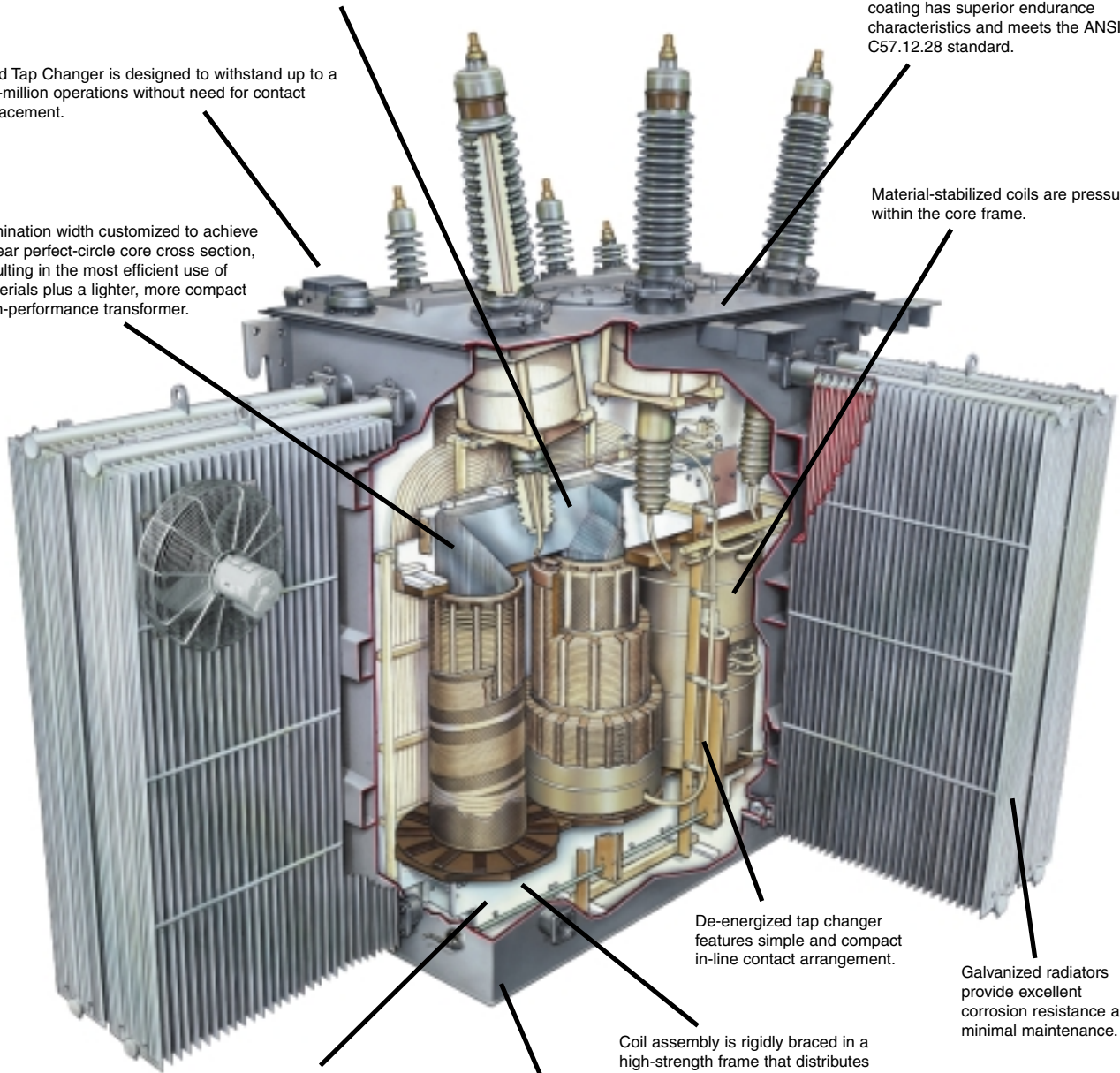

Inside tank surfaces are painted white to facilitate internal inspection.

De-energized tap changer features simple and compact in-line contact arrangement.

Galvanized radiators provide excellent corrosion resistance and minimal maintenance.

Coil assembly is rigidly braced in a high-strength frame that distributes clamping forces around the full circumference of the windings.

Submerged-arc process produces deep weld penetration, virtually eliminating leakage from welded tank joints.

Waukesha Electric Systems offers component parts for transformer upgrades and repair, as well as extensive field service support that includes transformer moving, hauling and rigging, vacuum filling and oil processing, inspection, testing and customer training.



WAUKESHA ELECTRIC SYSTEMS

World Headquarters:
400 S. Prairie Avenue
Waukesha, WI 53186-5940
800.835.2732

U.S. Manufacturing:
Waukesha, WI 800.835.2732
Goldsboro, NC 800.758.4384

Service, Parts, Training:
High Voltage Supply
Dallas, TX 800.338.5526

energy solutions ...to power your future

Fro

Mismatch - -Thru- Currents

- CT ratios
- Tap Settings

① HU - 87T

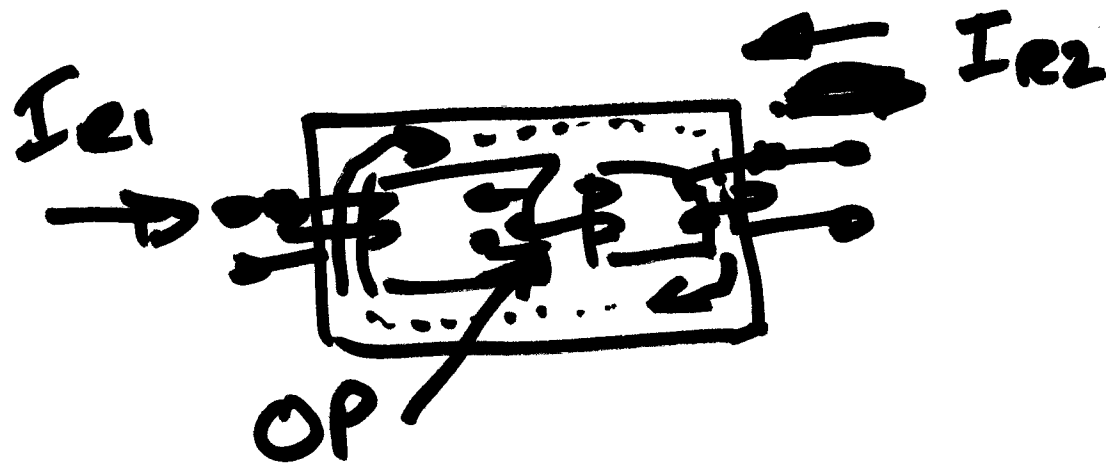
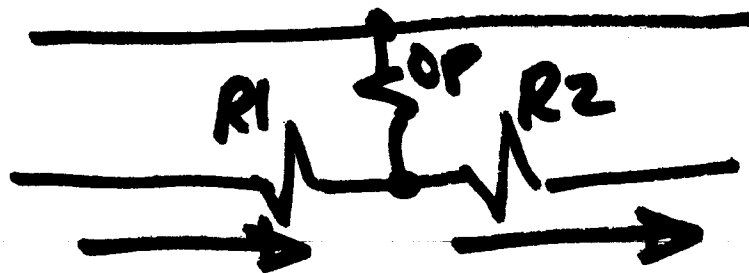

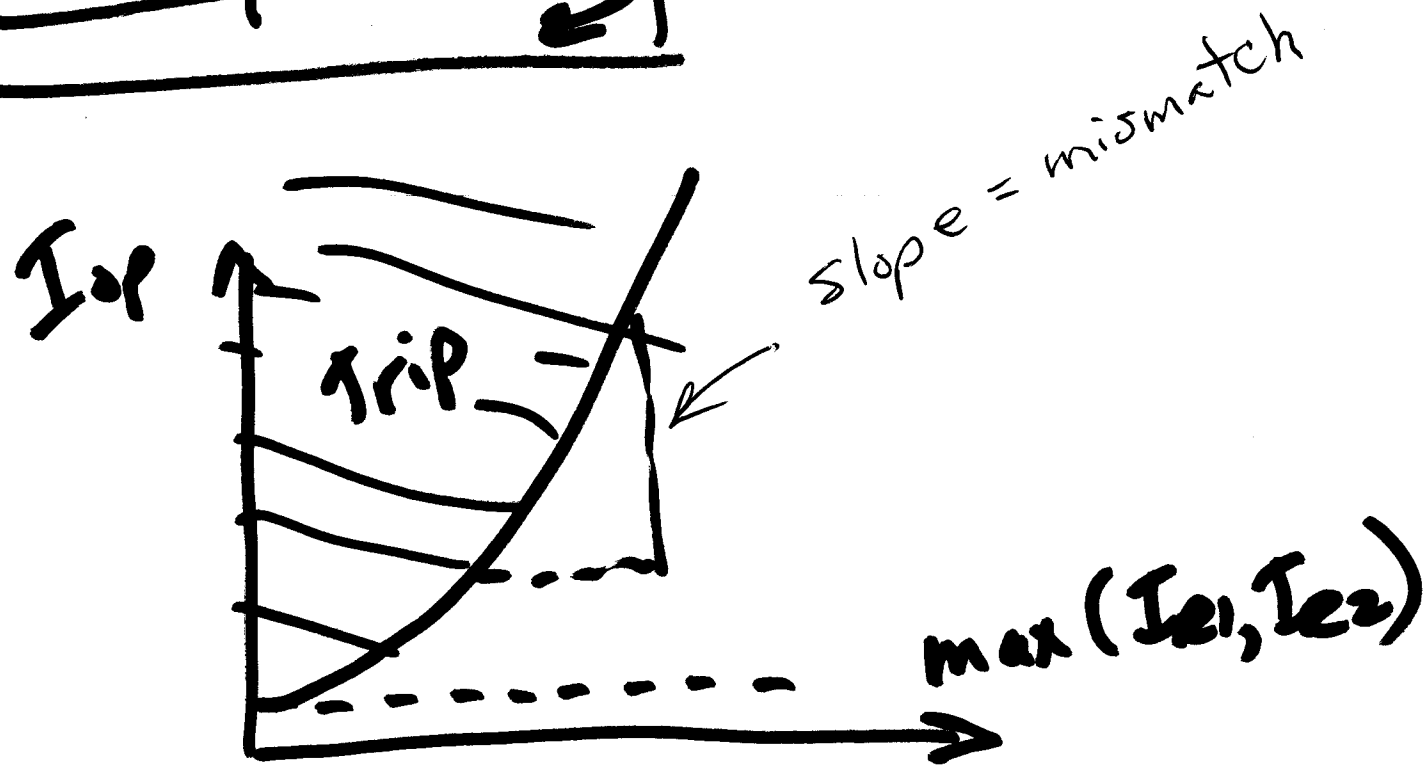
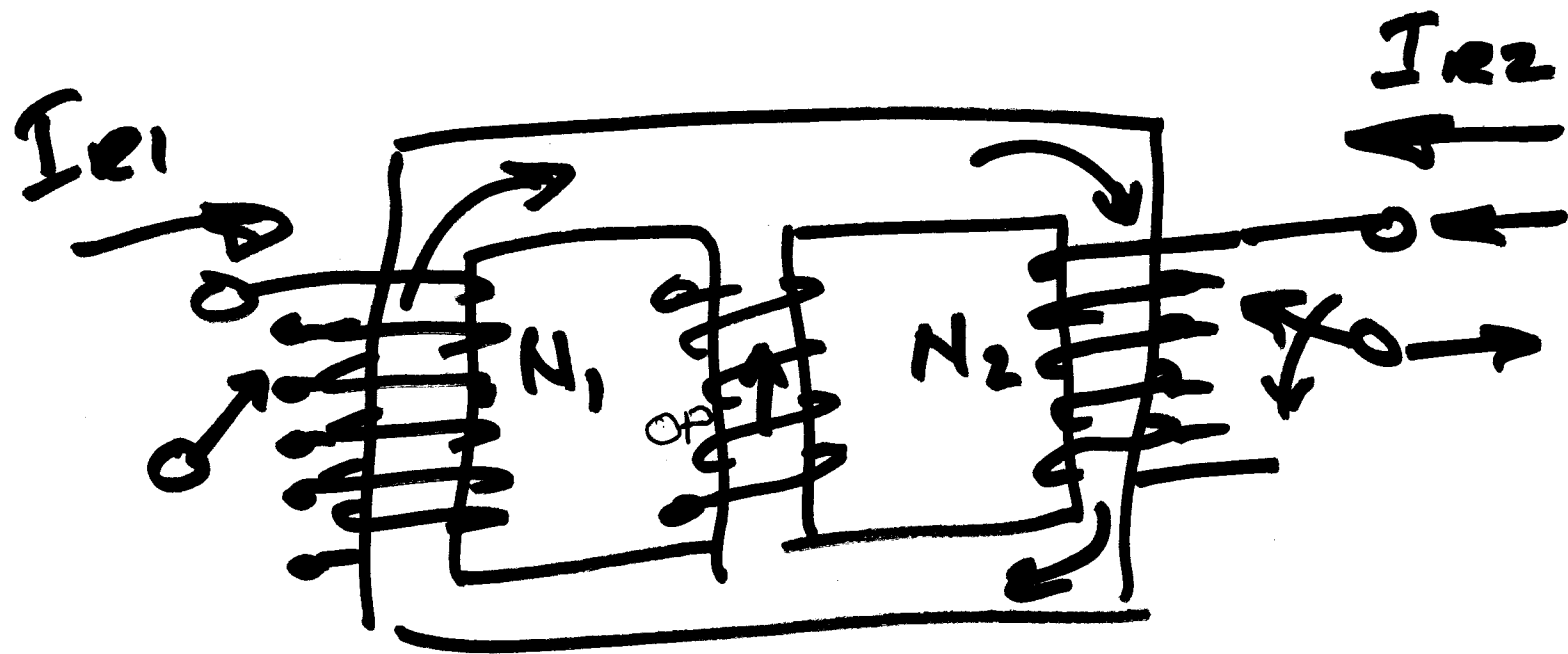

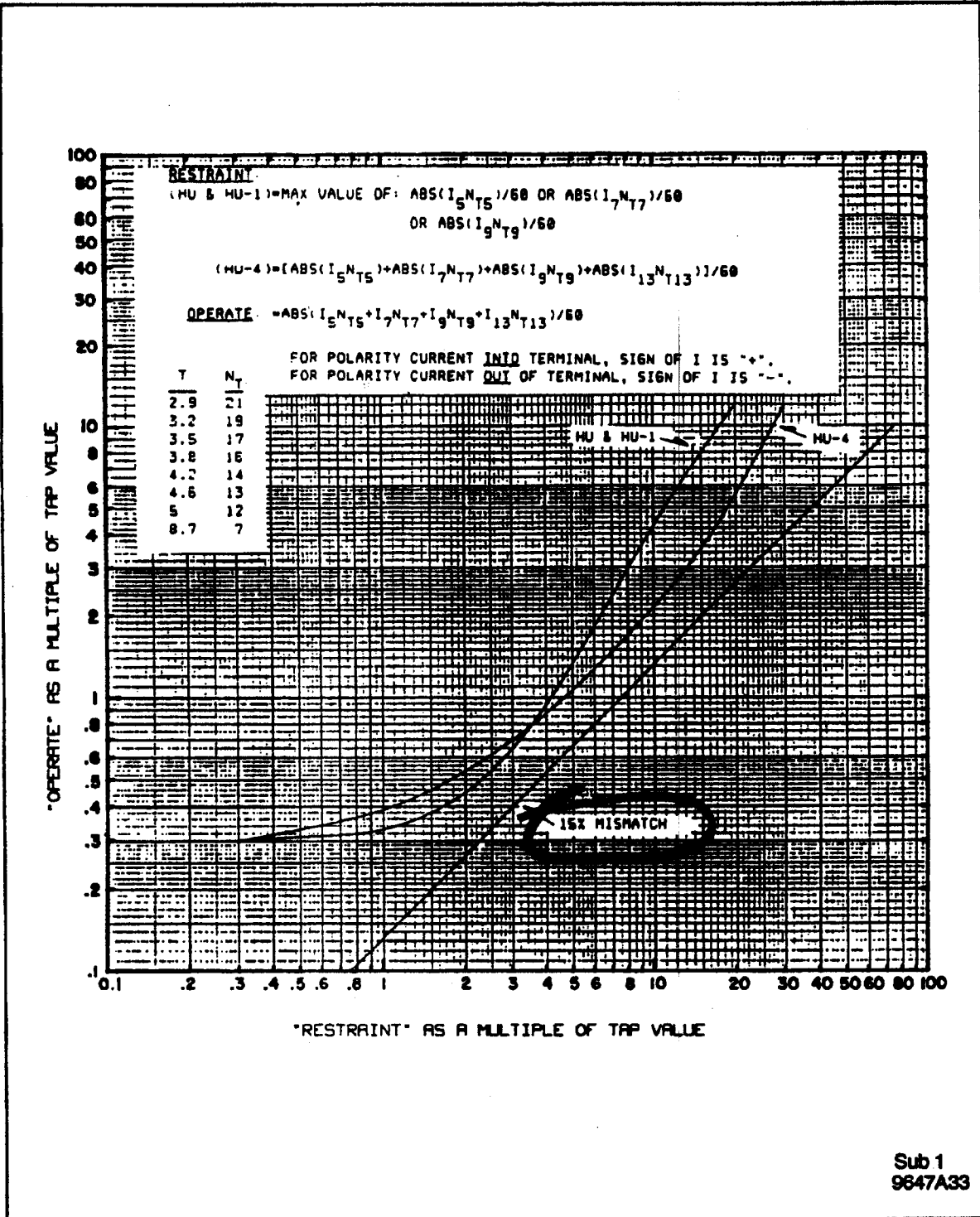
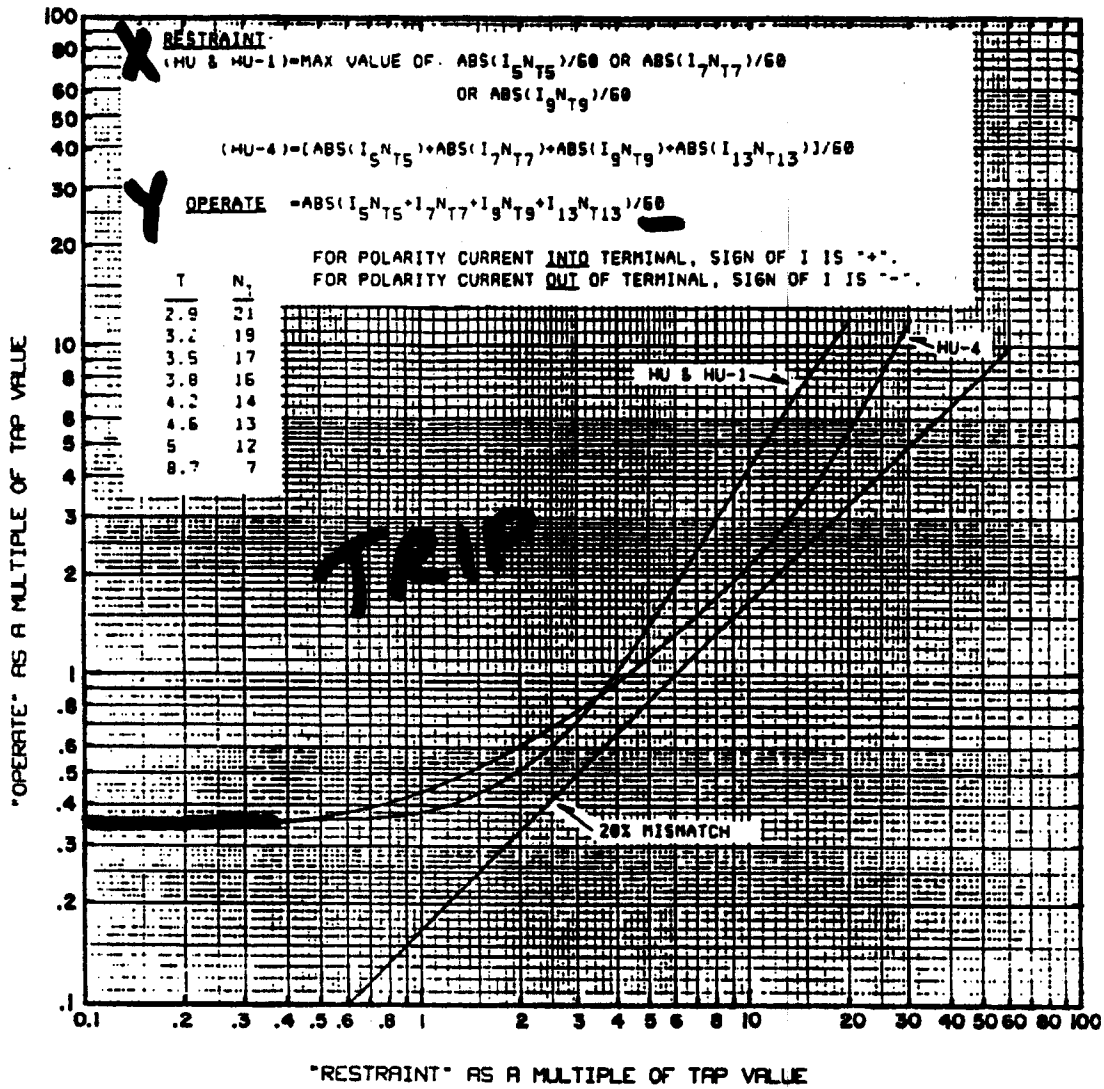

Figure 13. HU, HU-1 and HU-4 Differential Characteristics (30% Sensitivity).



Hu



Sub 1
 9647A34

Figure 14. HU, HU-1 and HU-4 Differential Characteristics (35% Sensitivity).

⇒ SSC° rise (self-cooled) 'OA' or ~~ONAN~~
"ONAN"

Base MVA for S.C. Calcs.

ΔT

3 - 4 - 5 ratio

SSC° rise:

18 / 24 / 30 MVA

65C° rise:

20.2 / 26.9 / 33.6 MVA

+12.5%

(Refer to
p. 5 of
XFMR Prot notes
posted in week 10)

↑
"passive"
Self-Cooled

↑
half
of
active
Cooling

↑
all
of
active
Cooling

Transformer Protection

EE 490C/590C Homework

25 pts

You are an applications engineer. You are given the spec of a new transformer that has just been ordered, and told to develop the protective relaying scheme.

The transformer rating is given as:

18/24/30-MVA @ 55C° rise
 20.2/26.9/33.6-MVA @ 65C° rise
 Two-winding
 69,000 volts Grounded Wye to 12,470 volts Delta
 Nonstandard phase shift: Wye leads by 150°
 LTC on secondary ($\pm 10\%$ in 5/8% steps)

High side CTs are 600:5 multi-ratio, C800, 3 sets of three
 Low side CTs are 2000:5 multi-ratio, C800, 2 sets of three
 Neutral CT is 1200:5 multi-ratio, C800.

Low side CTs to be used for the 87T scheme are on the LV switchgear. They are 1200:5 single ratio, C100. LV interruption is provided by the switchgear breaker; HV interruption by sending a transfer trip to the other end of the 69-kV line.

Also specified with the transformer are a sudden pressure relay, a low-low oil level trip contact, a high-high winding hot spot contact, and a high-high top oil temperature contact.

- 5 a - Draw a one-line of the transformer. Show the transformer and the connected LV switchgear. Show all CTs and ratios. Show 87T connections. Show trip contacts from alarm devices. Provide correct ANSI device designation numbers.
- 5 b - Draw out a three-line, showing correct phase connections of the 87T relays.
- 5 c - Determine the ratios for the multi-ratio CTs, assuming max load current for 65C° operation.
- 5 d - Select tap settings for the relays. Use the Westinghouse relays that are described in the handout you were given in class.
- 5 e - Calculate the mismatch, including the effects of the load tap changer. Come up with at least an acceptable combination of CT ratios and tap settings. You may want to try various combinations, but make sure that the load current does not exceed the CT ratio you use.
- 5 f - Do the burden calculations ~~to~~ confirm that the CTs are within their accuracy range? Assume the source impedance for faults from the 69-kV side is 0.2 per unit on a 100 MVA base and that there is no fault source on the low voltage side. Ignore the impedance of the connecting cables. Is the C100 CT within its operating range?

EE490C/590C

DIFF RELAY CONNECTIONS - Homework

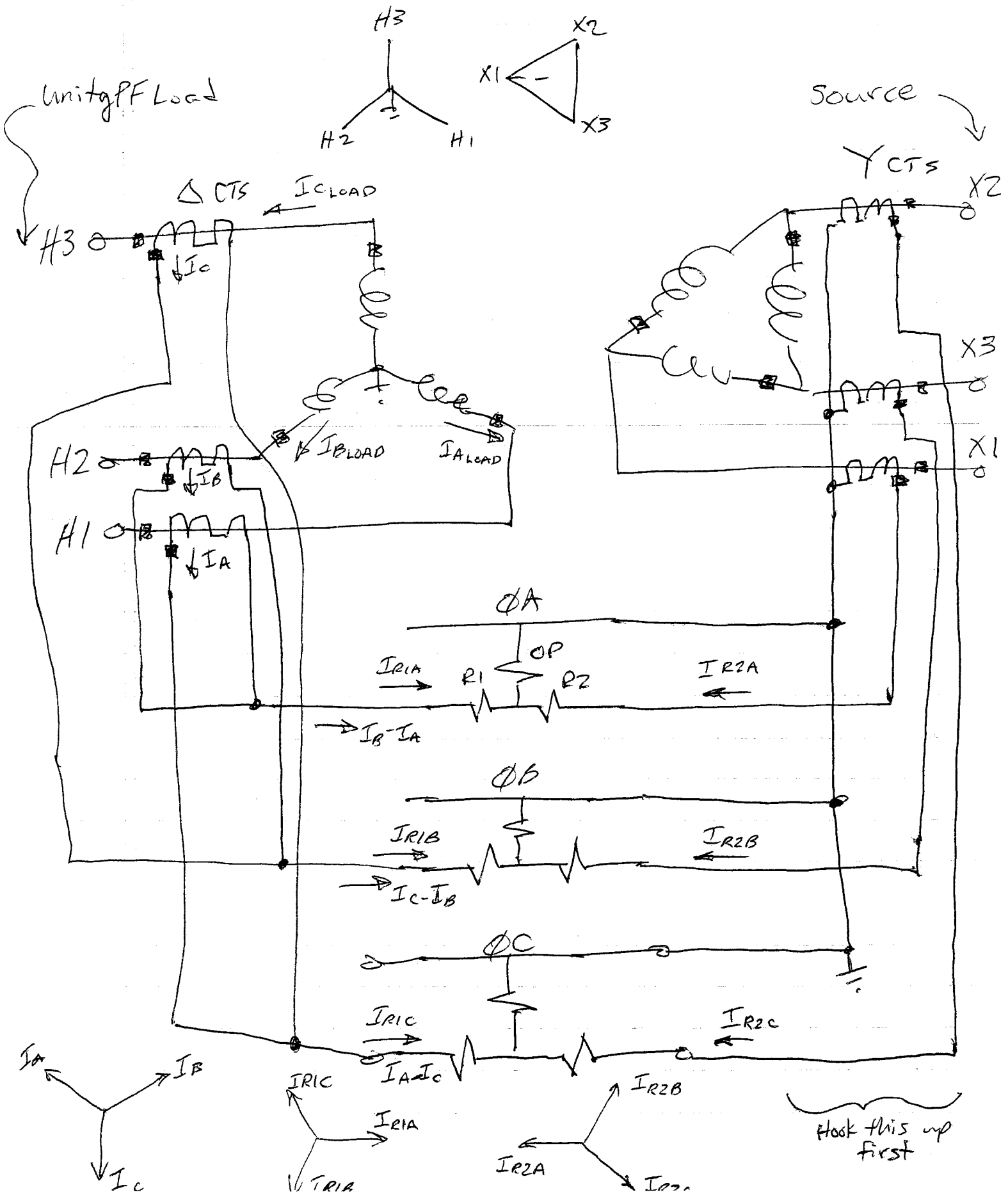

Transformer Diff Relay

a) One-Line of XFMR & Relaying

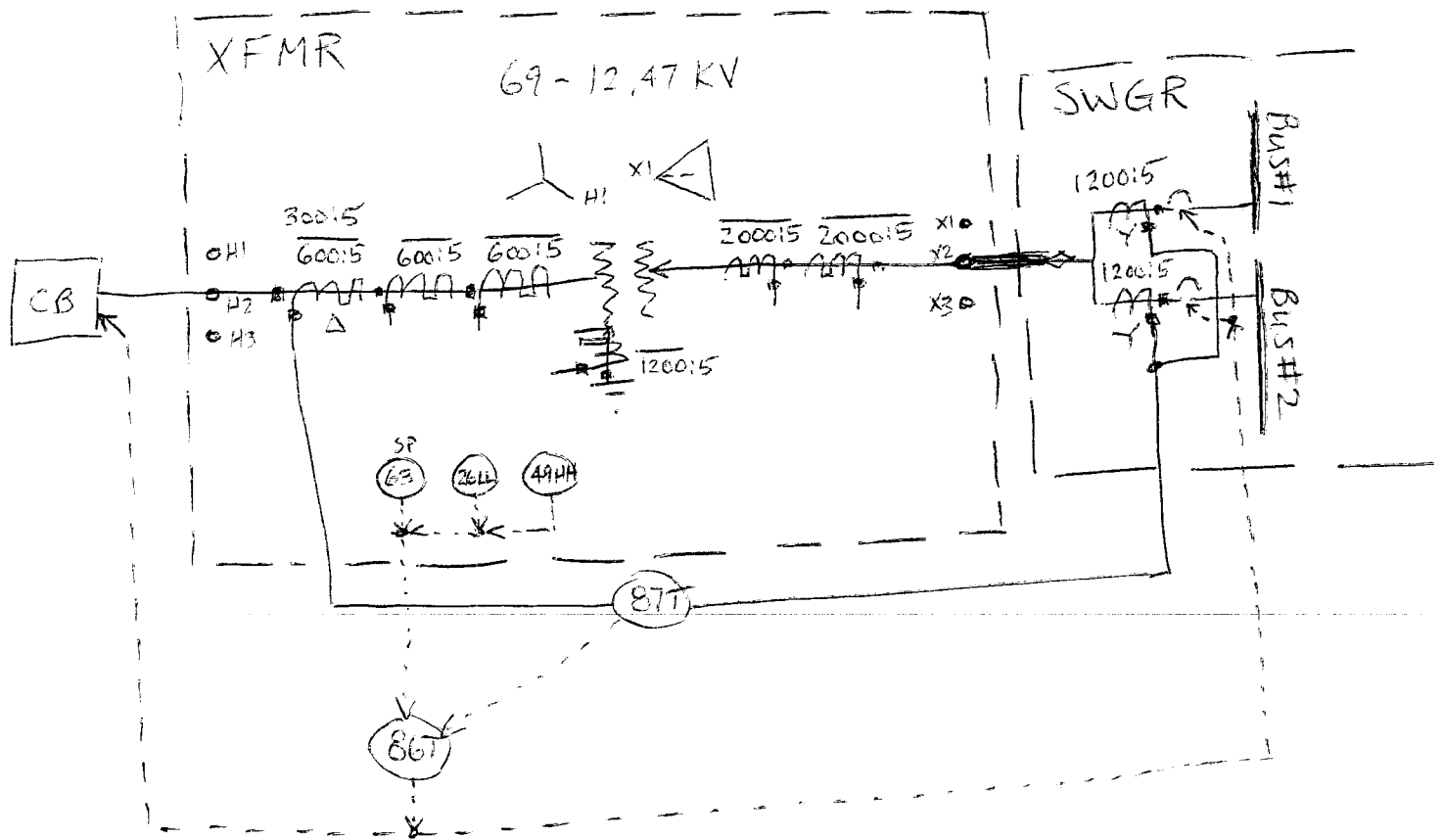

b) Three Line is given on separate sheet.

c) @ 33.6 MVA, $I_H = \frac{33.6 \text{ M}}{\sqrt{3}(69 \text{ k})} = 281 \text{ A}$

$I_L = \frac{33.6 \text{ M}}{\sqrt{3}(12.47 \text{ k})} = 1555 \text{ A}$

Based on I_{LOAD} ,

CTR = 300:5

CTR = Fixed
(2-1200:5 CTs paralleled)

d) $I_{RH} = \sqrt{3}(281) \left(\frac{5}{300} \right) = 8.11 \text{ A}$

$I_{RX} = 1555 \frac{5}{1200} = 6.48 \text{ A}$

Current Ratio = $\frac{8.11}{6.48} = 1.25$

$\frac{T_H}{T_L} = \frac{4.6}{3.8} = 1.211$ (One Possible Choice)

$\frac{T_H}{T_L} = \frac{8.7}{8.7} = 1.000$ (another choice)

$$e) \text{ Mismatch} = \frac{1.25 - 1.211}{1.211} = 0.0322 \quad (3.2\%)$$

($T_H = 4.6, T_L = 3.8$)

$$\text{Mismatch} = \frac{1.25 - 1}{1} = 25\% \quad (\text{Too High!})$$

($T_H = T_L = 8.7$)

Use $T_H = 4.6$
 $T_L = 3.8$ (Assume not greater than energy requirement)

Total Mismatch, including LTC is 13.2%,
 Better choose 30% diff slope.

f) Thru-Fault: $I_F = \frac{1.0}{j0.2 \text{ p.u.}} = -j5 \text{ p.u.}$

$$I_{\text{BASE } 69\text{KV}} = \frac{100\text{M}}{\sqrt{3} 69\text{K}} = 836\text{A}$$

$$I_{\text{BASE } 12\text{KV}} = \frac{100\text{M}}{\sqrt{3} 12.47\text{K}} = 4630\text{A}$$

$$\therefore \left. \begin{aligned} I_{RH} &= \frac{5 \times 836}{\sqrt{3} \frac{600}{5}} = \underline{60.5\text{A}} \\ I_{RL} &= \frac{5 \times 4630}{1200/5} = \underline{96.5\text{A}} \end{aligned} \right\} \begin{aligned} &\text{Assume} \\ &I_{\text{EXT}} = 100 \end{aligned}$$

Burdens: $MpVc1 - (I_{\text{EXT}} - 100)R_s \stackrel{?}{\geq} I_{\text{EXT}}Z_T$

HV: $Z_T = \frac{.45}{.46} \Rightarrow (5)(800) \stackrel{?}{\geq} (100)(\frac{.45}{.46})$ Yes!
HV is OK.

LV: $Z_T = \frac{.15}{3.8} \Rightarrow 100 \stackrel{?}{\geq} (100)(\frac{.15}{3.8})$ Yes!
LV is OK.

↑
 Assumes only one set of CTs. Actually 2 in parallel.

Indicating Contactor Switch (ICS)

No setting is required on the ICS unit except the selection of the 0.2 or 2.0 ampere tap setting. This selection is made by connecting the lead located in front of the tap block to the desired setting by means of the connecting screw. When the relay energizes a 125-or 250-volt dc type WL relay switch, or equivalent, use the 0.2-ampere tap; for 48 volt DC applications set relay in 2 tap and use Type WL Relay coil S#304C209G01 or equivalent.

Indicating Instantaneous Trip (IIT)

No setting is required on the indicating instantaneous trip unit. This unit is set at the factory to pickup as follows:

HU/HU-1 Relays 10 times tap value current
 HU-4 Relay 15 times tap value current

SETTING CALCULATIONS

Select the ratio matching taps. There are no other settings. In order to calculate the required tap settings and check current transformer performance the following information is required.

Required Information

1. Maximum transformer power rating (KVA)_M
2. Maximum external fault currents
3. Line-to-Line voltage ratings of power transformer (V_{HL}, V_I, V_L)
4. Current transformer ratios, full tap (N_T)
5. Current transformer "C" accuracy class voltage, (or excitation or ratio correction factor curve)
6. One way current transformer lead resistance at 25°C (R_L) (when using excitation curve, include ct winding resistance)
7. Current transformer connections (wye or delta)
8. ct secondary winding resistance, R_S.

Definitions of Terms

I_P = Primary current at (KVA)_M

I_R = Relay input current at (KVA)_M

I_{RH}, I_{RL}, I_{RI} are same as I_R except for high, low and intermediate voltage sides respectively.

I_S = ct secondary current at (KVA)_M

Γ = relay tap setting.

T_H, T_L, T_I = are same as T except for high, low and intermediate voltage windings, respectively.

N = Number of current transformer turns that are in use.

N_P = N/N_T (Proportion of total turns in use)

N_T = Current transformer ratio, full tap

V_{CL} = "C" accuracy class voltage

Z_A = Burden impedance of any devices other than the HU, HU-1, or HU-4 relays, with maximum external fault current flowing.

I_{ext} = max. symmetrical external fault current in secondary RMS amperes.

Z_T = Total secondary burden in ohms (excluding current transformer winding resistance.)

Calculation Procedure

1. *Select current transformer taps*, where multi-ratio types are used. Select a tap to give approximately 5 amperes at maximum load. This will provide good sensitivity and will produce no thermal problem to the ct., the leads or the relay. Better sensitivity can be achieved by selecting a tap to give more than 5 amperes if a careful check is made of the ct, the leads and the relay capability. For determining the required continuous rating of the relay, use the expected two-hour maximum load, since the relay reaches final temperature in this time.
2. *Calculate the relay currents, I_R*. All relay currents for relay tap selection should be based on the same KVA capacity.
3. *Calculate the relay current ratio(s)* using the lowest current as reference.
4. *Select the tap ratio as close as possible to relay current ratio from Table 1*. Choose the first relay tap ratio using the largest current ratio from step 3. The other tap ratios should be determined using the lower tap from the first tap ratio as reference.

$N_p V_{cl} + 100 R_s > I_{ext} Z_T + I_{ext} R_s$ secondary winding resistance

I_R should not exceed relay continuous rating as defined in Energy Requirement Table.

$$\frac{[N_p V_{cl} - (I_{ext} - 100) R_s]}{I_{ext}} \text{ is greater than } Z_T \quad (2)$$

Note: let $I_{ext} = 100$

if I_{ext} where maximum external fault current is less than 100A.

5. **Check IIT operation.** The IIT pickup is ten times the relay tap value for the HU and HU-1, or 15 times tap value for the HU-4. Therefore, the maximum symmetrical error current which is flowing in the differential circuit on external fault current due to dissimilar ct saturation should not exceed 10 or 15 times relay tap.

For wye-connected ct:

$$\begin{aligned} Z_T &= \text{lead resistance} + \text{relay burden} + Z_A \\ &= 1.13 R_L + \frac{0.15}{T} + Z_A \text{ ohms} \quad (3) \end{aligned}$$

(R_L multiplier, 1.13, is used to account for temperature rise during faults $\frac{0.15}{T}$ is an approximation. Use 2 way lead resistance for single phase to ground fault.)

6. **Determine Mismatch**

For 2 winding banks:

$$\% \text{ mismatch} = 100 \frac{(I_{RL}/I_{RH}) - (T_L/T_H)}{S} \quad (1)$$

where S is the smaller of the two terms, (I_{RL}/I_{RH}) or (T_L/T_H)

For 3 winding banks:

Repeat calculation of equation (1) and apply similar equations to calculate mismatch from the intermediate to high and from the intermediate to low voltage windings.

For delta-connected ct:

$$\begin{aligned} Z_T &= 3 (1.13 R_L + \frac{0.15}{R} + Z_A) \text{ ohms} \\ &= 3.4 R_L + \frac{0.45}{T} + 3Z_A \quad (4) \end{aligned}$$

*(The factor of 3 accounts for conditions existing during a phase fault.)

8. **Examples**

Refer to pages 19, 20 and 21 and figure 21 for setting examples.

Where tap changing under load is performed the relays should be set on the basis of the middle or neutral tap position. The total mismatch, including the automatic tap change should not exceed 15% with a 30% sensitivity relay, and 20% with a 35% sensitivity relay. Note from Fig. 11 that an ample safety margin exists at these levels of mismatch.

7. **Check current transformer performance.**

Ratio error should not exceed 10% with maximum symmetrical external fault current flowing. An accurate method of determining ratio error is to use ratio-correction-factor curves (RCF). A less accurate, but satisfactory method is to utilize the ANSI relaying accuracy classification. If the "C" accuracy is used, performance will be adequate if:

TABLE 1

HU Relay Tap Ratios

	2.9	3.2	3.5	3.8	4.2	4.6	5.0	8.7
2.9	1.000	1.103	1.207	1.310	1.448	1.586	1.724	3.000
3.2		1.000	1.094	1.188	1.313	1.438	1.563	2.719
3.5			1.000	1.086	1.200	1.314	1.429	2.486
3.8				1.000	1.105	1.211	1.316	2.289
4.2					1.000	1.095	1.190	2.071
4.6						1.000	1.087	1.890
5.0							1.000	1.740
8.7								1.000

INSTALLATION

The relays should be mounted on switchboard panels or their equivalent in a location free from

TWO-WINDING TRANSFORMER CALCULATIONS (See Figure 21)

	<u>LOW</u>	<u>HIGH</u>
1. <u>Select ct Ratio</u>		
$I_P = \frac{(KVA)_M}{(KV)\sqrt{3}} =$	$\frac{20,000}{12.4\sqrt{3}} = 930 \text{ Amp.}$	$\frac{20,000}{69\sqrt{3}} = 167 \text{ Amp}$
Select Ratio	1000/5 (N = 200)	200/5 (N = 40)
2. <u>Calculate Relay Current:</u>		
$I_S = \frac{I_P}{N} =$	$\frac{930}{200} = 4.65 \text{ Amp.}$	$\frac{167}{40} = 4.18 \text{ Amp.}$
$I_R =$	$I_{RL} = 4.65\sqrt{3} = 8.05 \text{ Amp.}$	$I_{RH} = 4.18 \text{ Amp.}$
3. <u>Calculate Current Ratio:</u>		
		$\frac{I_{RL}}{I_{RH}} = \frac{8.05}{4.18} = 1.93$
4. <u>Select Tap Ratio from Table 1:</u>		
		$\frac{T_L}{T_H} = \frac{8.7}{4.6} = 1.890$
$I_R > \text{relay continuous rating}$	No	No
5. <u>Check IIT Operation</u> Max. Symmetrical error current > 10 times relay tap.		No
6. <u>Determine Mismatch:</u> % Mismatch =		
$100 \frac{(I_{LR}/I_{RH}) - (T_L/T_H)}{T_L/T_H} =$		$100 \frac{(8.05/4.18) - (8.7/4.6)}{8.7/4.6} =$
		$100 \frac{1.92 - 1.89}{1.89} = 1.6\%$
7. <u>Check ct Performance</u> $\frac{Z_T}{N_T} =$		
	$3.4 R_L + \frac{0.45}{T} =$	$1.13 R_L + \frac{0.15}{T} =$
	$3.4 \times 0.4 + \frac{0.45}{8.7} = 1.36 + 0.05 =$	$1.13 \times 0.4 + \frac{0.15}{4.6} = 0.45 + 0.03 =$
	<u>1.41 ohms</u>	<u>0.48 ohms</u>
	$\frac{200}{240} = 0.833$	$\frac{40}{120} = 0.333$
	$\frac{0.833 \times 200}{100} = \underline{1.67}$	$\frac{0.333 \times 200}{100} = 0.67$
	Yes	Yes
$(N_P V_{CL}/100) > Z_T$		
<u>Conclusion:</u>	$T_L = 8.7$	$T_H = 4.6$
	30% sensitivity Relay is adequate	

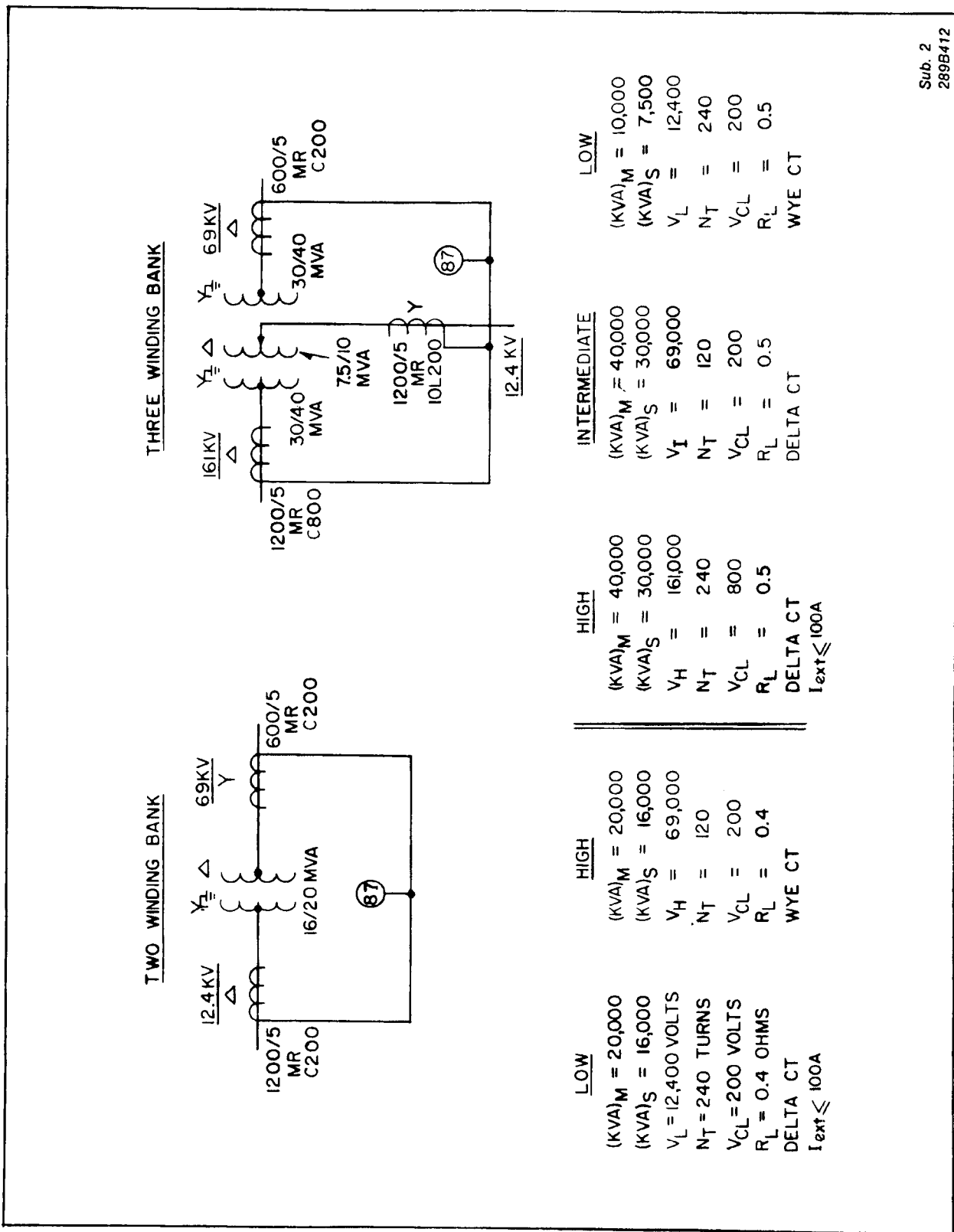

Sub. 2
289B412

Fig. 21. Example for Setting Calculations.