

Effective: February 1994
Supersedes I.L. 41-337.4G, Dated August 1985

⊕ Denotes change since previous issue

Type KAB High Impedance Bus Differential Relay (50 and 60 Hz)



Before putting relays into service, remove all blocking which may have been inserted for the purpose of securing the parts during shipment. Make sure that all moving parts operate freely. Inspect the contacts to see that they are clean and close properly, and operate the relay to check the settings and electrical connections.

Note: These instructions apply to 50 and 60 Hertz relays

1.0 APPLICATION

The type KAB relay is an instantaneous relay of the high impedance type used for bus differential protection.

1.1 APPLICATION CONSIDERATIONS

The type KAB relay can be applied for bus protection in most cases where bushing type ct's are in use, and in metal-clad equipment where ct's with toroidally wound cores have their windings completely distributed are employed. Figure 10, shows the external connection.

The following points should be considered or should be known on any proposed type KAB relay application.

1. All ct's in the bus differential circuit should have the same ratio, and should be operated on their full tap. If tap connection cannot be avoided, the winding section between the taps being used

must be fully distributed and the high voltage which may appear at the full tap terminal due to the autotransformer action should be checked.

2. The leakage impedance of the ct's which are to be used should be low.
3. The use of the auxiliary ct's is not recommended. If this cannot be avoided the additional impedance from the auxiliary ct's and the high voltage which transformed by the auxiliary ct should be checked.
4. The best location for the junction points is electrically equidistant from all ct's if all ct's are identical.
5. The lead resistance from the junction points to the relay terminals is not critical.
6. A lockout relay contact is recommended to short circuit the varistor following the relay operation in order to prevent the varistor from overheating.

It is recommended that the 86B contact be wired between terminals 9 and 6 to short out the varistor only. Following 86B operation the IT unit is inserted in the differential circuit as a straight overcurrent function allowing for the possibility of using the KAB to energize a breaker failure initiating relay, 62Z, as shown in Figure 10.

7. To insure a substantial margin of operation on internal faults, the V-unit should not be set higher than the knee voltage, V_K , value of the **poorest** ct which is connected to the relay.

To insure a substantial margin for preventing the relay from operation on external faults, the knee

All possible contingencies which may arise during installation, operation or maintenance, and all details and variations of this equipment do not purport to be covered by these instructions. If further information is desired by purchaser regarding this particular installation, operation or maintenance of this equipment, the local ABB representative should be contacted.

voltage value of the **best** ct which is connected to the relay should be used to determine the value of $(R_S + R_L) I_F / NV_K$ in Figure 8.

The knee voltage is defined as the intersection of the extension of the two straight line portions of the saturation curve. Ordinate and abscissa must be same scale for each decade.

8. A high voltage may be developed across the relay on internal faults. The magnitude of the voltage that can be developed is a function of the total fault current and the characteristics of the ct's used in the differential circuit. The varistor(s) which is built into the relay is used to limit this high voltage to a safe level. Curves in Figure 12, should be used to investigate the application limit.

If the fault current $\frac{I_F}{N}$ and knee point voltage (V_K) are such that the intersection of these two points plot below the curve, then the application will be safe with respect to the limits for 4 cycle clearing time.

9. The maximum number of circuits which can be connected to the relay or the minimum internal fault current required to operate the relay can be estimated from the following equation.

$$I_{\min} = (X I_e + I_R + I_V) N$$

where I_{\min} = minimum internal fault current, RMS.

I_e = ct secondary excitation current at a voltage equal to the setting value of V-unit.

I_R = Current in V-unit at setting voltage V_R (i.e. $I_R = V_R/2600$)

I_V = Current in varistor circuit at a voltage equal to the setting value of V-unit.

N = ct turn's ratio.

X = Number of circuits connected to the bus.

2.0 CONSTRUCTION

The relay (see Figure 1) consists of a high speed overvoltage cylinder unit (V), a high speed overcurrent unit (IT), a voltage limiting suppressor (Varistor),

an adjustable reactor and capacitors for completing a tuned circuit.

2.1 OVERVOLTAGE UNIT V

The voltage unit is a product induction cylinder type unit operating on the interaction between the polarizing circuit flux and the operating circuit flux.

Mechanically, the voltage unit is composed of four basic components: A die-cast aluminum frame, an electromagnet, a moving element assembly, and a molded bridge.

The frame serves as the mounting structure for the magnetic core. The magnetic core which houses the lower pin bearing is secured to the frame by a locking nut. The bearing can be replaced, if necessary, without having to remove the magnetic core from the frame.

The electromagnet has two series-connected polarizing coils mounted diametrically opposite one another; two series-connected operating coils mounted diametrically opposite one another; two magnetic adjusting plugs; upper and lower adjusting plug clips, and two locating pins. The locating pins are used to accurately position the lower pin bearing, which is threaded into the bridge. The electromagnet is secured to the frame by four mounting screws.

The moving element assembly consists of a spiral spring, contact carrying member, and an aluminum cylinder assembled to a molded hub which holds the shaft. The shaft has removable top and bottom jewel bearing. The shaft rides between the bottom pin bearing and the upper pin bearing with the cylinder rotating in an air gap formed by the electromagnet and the magnetic core.

The bridge is secured to the electromagnet and frame by two mounting screws. In addition to holding the upper pin bearing, the bridge is used for mounting the adjustable stationary contact housing. The stationary contact housing is held in position by a spring type clamp. The spring adjuster is attached to the moving contact arm by a spiral spring. The spring adjuster is also held in place by a spring type clamp.

With the contacts closed, the electrical connection is made through the stationary contact housing clamp, to the moving contact, through the spiral spring out to the spring adjuster clamp.

2.2 OVERCURRENT UNIT (IT)

The instantaneous unit is a small ac operated clapper type device. A magnetic armature, to which leaf-spring mounted contacts are attached, is attracted to

the magnetic core upon energization of the switch. When the switch closes, the moving contacts bridge two stationary contacts completing the trip circuit.

The core screw accessible from the top of the switch provides the adjustable pickup range.

The coil is tapped and the taps brought out to a tap block. By means of the Hi and Lo tap and the adjustable core, a pickup range of 16 to 1 may be obtained.

2.2.1 Varistor

The varistor is a non-linear voltage dependent resistor. It consists of a disc of electrical grade zinc oxide material mounted between cooling fins and connected in series. They are assembled in an integral mechanical assembly and should not be taken apart.

2.2.2 Reactor

The adjustable reactor is an air-gap type having two iron screws which are used at the factory to tune the circuit for maximum current at rated frequency. This feature allows retuning of the circuit in the event other parts of the circuit are replaced.

2.3 INDICATING CONTACTOR SWITCH UNIT (ICS)

The indicating contactor switch is a small dc operated clapper type device. A magnetic armature, to which leaf-spring mounted contacts are attached, is attracted to the magnetic core upon energization of the switch. When the switch closes, the moving contacts bridge two stationary contacts, completing the trip circuit. Also during this operation two fingers on the armature deflect a spring located on the front of the switch, which allows the operation indicator target to drop. The target is reset from the outside of the case by a push-rod located at the bottom of the cover.

The front spring, in addition to holding the target, provides restraint for the armature and thus controls the pickup value of the switch.

3.0 OPERATION

The relay is connected as shown in external connection Figure 10. For normal operation the voltage at the relay terminals is approximately zero. In the case of an external fault, the voltage at the relay terminals still remains approximately zero if both the source ct's and the faulted ct's are not saturated.

However, during severe external faults the faulted ct may saturate and no voltage or current can be developed from its secondary winding. The source ct's

would then have to force their currents through their own windings and through the winding and leads of the faulted ct. In this case a voltage would appear across the junction point equal to the total secondary currents of the source ct's multiplied by the resistance of the faulted ct secondary winding plus its leads to the junction point. The relay is usually set to operate at some voltage higher than the anticipated voltage expected for this condition. The fault voltage will be lower than the calculated voltage since the fault ct will always produce some voltage and also the source ct will tend to saturate. The dc offset component of this voltage does not affect the relay operation by reason of the series tuned circuit as well as the insensitivity of the voltage unit to dc.

In the case of an internal fault, the feeder ct's impedances, neglecting the load current, are equal to the magnetizing impedance which is high. Since the relay is high impedance, this makes a high impedance secondary burden to the source ct's, a high voltage will appear at the relay terminals and will be well above the pickup setting.

During severe internal faults the source ct will saturate to limit the RMS value of secondary voltage. However, the peak voltages of the wave form could be quite high and overstress the insulation. A varistor is connected internally to reduce this voltage. Figure 6, shows the electrical characteristics of this device.

The overvoltage unit is a high speed device and will operate in 2 cycles at twice pickup using a sine wave test voltage. Under fault condition, the crest voltage is rather high, the operating speed of the V-unit would be faster. Figure 11, shows the operating speed of 1.5 cycles from the typical staged faults, however, an overcurrent unit is provided which may be connected in series with the varistor and will operate in 1 cycle on current flow during severe internal faults when the varistor conducts current to limit the secondary voltage. The application of overcurrent unit has no effect on the operating speed of the voltage unit.

A high impedance bus differential relay will be subjected to high continuous voltage and will result in damage if any one ct is either open circuited or reversed polarity connection. The KAB relay with "in service ct check" feature, as shown in Figure 3, will solve this problem. Before putting the relay into service, close all switch handles except terminals 4, 9 and 10. This shunts the high impedance elements, the varistor and the voltage unit, and prevents overvoltage. An ammeter can be inserted to the current test jack at terminal 9. A reading equal to one ct secondary current indicates an open ct connection; a

reading equal to twice the ct secondary current indicates a reverse ct connection. The misconnected ct can be identified by shorting and removing each ct in turn from the junction points.

4.0 CHARACTERISTICS

50 and 60 Hertz Relays

4.1 OVERVOLTAGE UNIT (V)

The range of pickup of the overvoltage unit is adjustable from 75 to 200 or 150 to 400 volts. The pickup is obtained by means of adjusting the spring windup.

Speed of operation is 2 cycles at twice pickup, (sine wave test voltage).

4.2 OVERCURRENT UNIT (IT)

The range of the overcurrent unit is 3 to 48 amperes. A tap is used to obtain this by use of two settings (Hi and Lo). The Lo setting permits the core screw to be adjusted over a 3 to 12 ampere range. The Hi setting permits a 12 to 48 ampere range of adjustment. The scale plate is calibrated in multiples of minimum pickup. The pickup should be within $\pm 10\%$ of the setting.

4.3 INDICATING CONTACTOR SWITCH (ICS)

No setting is required for relays with a 1.0 ampere unit. For relays with a 0.2/2.0 ampere unit, connect the lead located in front of the tap block to the desired setting by means of the connecting screw. When the relay energizes a 125 - or 250-volt dc type WL relay switch, or equivalent, use the 0.2 ampere tap; for 48 volt dc applications set the unit in a tap 2 and use a Type WL relay with a style number 304C209G01 coil, or equivalent.

4.4 TRIP CIRCUIT CONSTANTS

Contactor Switch -

1 ampere rating:	0.1 ohms dc resistance
0.2/2.0 ampere rating:	0.2 tap - 6.5 ohms 2 tap - 0.15 ohms

5.0 SETTING CALCULATIONS

5.1 SETTING VOLTAGE UNIT

The setting of the voltage can be expressed as follows:

$$V_R = K(R_S + R_L) \frac{I_F}{N}$$

where V_R = pick up setting of the V-unit, (RMS, volts).

R_S = dc resistance of ct secondary winding including internal leads to bushing terminals.

R_L = resistance of lead from junction points to the most distance ct. (One-way lead for phase to ground fault).

I_F = Maximum external fault current (RMS amp.) contributed by the bus.

N = ct turn's ratio

K = Margin factor

The margin factor is a modification number. It varies with the reciprocal of the ct saturation factor, i.e.,

$$\left[\frac{(R_S + R_L) I_F}{NV_K} \right]$$

Figure 8, shows the margin factor curve, which is based on the high Power Lab tests on the KAB relay and considers a safety factor of 2. The use of this curve is explained in the sample calculation.

5.2 SETTING CURRENT UNIT

The setting calculation for this unit is rather simple.

First, calculate the value of $(R_S + R_L) \left(\frac{I_F}{N} \right)$, then from curves in Figure 9, find the value for the setting. These curves have considered a safety factor of 2.

5.3 SAMPLE CALCULATION

Assume a 6 circuit bus, for which the maximum external 3-phase fault current is 60,000 amperes rms, symmetrical, maximum external phase to ground fault current is 45,000 amperes, and the minimum internal fault current is 10,000 amperes. Assume the ct's ratios are 2000:5, class C400, $V_K = 375$ volts, secondary winding resistance $R_S = 0.93\Omega$, and one way lead resistance to junction point $R_L = 1.07\Omega$.

5.3.1 Setting of Current Unit

Since $(R_S + R_L) \frac{I_F}{N} = (0.93 + 1.07) \times \frac{60000}{400} = 300$

for 3-phase fault.

$$(R_S + R_L) \frac{I_F}{N} = (0.93 + 1.07) \times \frac{45000}{400} = 345$$

for phase to ground fault.

From Figure 9, using the higher number of 345 the current unit setting is determined to be 12 amperes. Set the overcurrent unit at 15 amp.

5.3.2 Setting of Voltage Unit

a) for 3-phase fault condition

$$\left[(R_S + R_L) \frac{I_F}{N} \right] / V_K = (0.93 + 1.07) \times \frac{60000}{400} / 375 = 0.8$$

from Figure 8, $K \geq 0.82$

$$\therefore V_R = K(R_S + R_L) \frac{I_F}{N}$$

$$V_R \geq 0.82(0.93 + 1.07) \times \frac{60000}{400} = 246 \text{ volts}$$

b) for phase to ground fault condition

$$\left[(R_S + R_L) \frac{I_F}{N} \right] / V_K = (0.93 + 1.07) \times \frac{45000}{400} / 375 = 0.92$$

from Figure 8, $K \geq 0.77$

$$\therefore V_R = K(R_S + R_L) \frac{I_F}{N}$$

$$V_R \geq 0.77(0.93 + 2 \times 1.07) \times \frac{45000}{400} = 266 \text{ volts}$$

Choose the maximum of (a) and (b), to prevent the relay from false pickup on external faults, its minimum setting should be at least this maximum 266 volts. This adjustment is made by varying the spring tension. See "Routine Maintenance".

c) The minimum fault current required to operate the relay at the setting of 266 volts. Assume that from the ct saturation curve $I_e = 0.045$ amp. at 266 volts. And from Figure 7, I_V is less than 0.01 amp. at 266 V(RMS) and may be ignored.

$$I_{\min} = (X I_e + I_R + I_V) N$$

$$= \left(6 \times 0.045 + \frac{266}{2600} + 0 \right) 400$$

$$= 0.3732 \times 400 = 149 \text{ amp}$$

6.0 INSTALLATION

The relays should be mounted on switchboard panels or their equivalent in a location free from dirt, moisture, excessive vibration and heat. Mount the relay vertically by means of the two mounting studs for the type FT projection case or by means of the four mounting holes on the flange for the semi-flush type FT case. Either of the studs or the mounting screws may be utilized for ground the relay. The electrical connections may be made directly to the terminals by means of screws for steel panel mounting or to terminal studs furnished with the relay for thick panel mounting. The terminal studs may be easily removed or inserted by locking two nuts on the studs and then turning the proper nut with a wrench.

For detailed FT case information, refer to I.L. 41-076.

External Connections are made per external connection drawing (Figure 10).

RATINGS 50 and 60 Hertz Relays

Device	Continuous	
Range	75-2000V	150-400V
Overvoltage Unit (V)	250 volts ac	250 volts ac
	300 volts ac	400 volts ac
	(15 seconds)	(15 seconds)
Varistor	200 volts ac	350 volts ac
Overcurrent Unit (IT)		
Lo Range	2.5 Amps	
Hi Range	100 Amps (1 second)*	
	10 Amps	
	200 Amps (1 second)*	
Indicating Contactor Switch (ICS)		
1.0 Amp Rating	5.0 Amps	
0.2/2.0 Amp Rating	140 Amps (1 second)	
	0.2 Amp tap	
2.0 Amp tap	0.4 Amps	
	11.5 Amps (1 second)	
	3.5 Amps	
	88 Amps (1 second)	

Note that the Varistor is brought out to a separate terminal to provide flexibility in using the overcurrent unit. It must be connected in service. In addition, the contacts of an auxiliary 86 device should be wired across the relay terminals to protect the Varistor against prolonged overload.

Make in-service ct check as described in the last paragraph of "OPERATION".

6.1 TRIP CIRCUIT

The overvoltage contacts will safely close 30

amperes at 250 volts dc and the seal-in contacts of the indicating contactor switch carry this current long enough to trip a circuit breaker.

6.2 BURDEN

The relay burden is approximately 2600 ohms in the tuned circuit. However, this burden is not seen by any of the CTS during normal operation or during an external fault. During an internal fault the source CT sees a burden composed of the 2600 ohms in parallel with the Varistor resistance plus the parallel impedance of the unloaded feeder CTS. The resistance of the Varistor can be calculated from the volt-ampere curve Figures 6 and 7.

7.0 ACCEPTANCE CHECK

7.1 OVERVOLTAGE UNIT (V)

The overvoltage unit has been set at the factory for 75 volts pickup for the 75-200V relay (150 volts for the 150-400V relay). If a different pickup is desired, the relay should be energized from a variable voltage source. Terminal 8 and 9 should be energized. The varistor should not be connected when making adjustments for greater than 350 Vac. The voltage unit can withstand 250 volts ac, continuously and up to 300 volts ac (400 volts for the 100-400V range) for 15 seconds.

The pickup is increased by winding the spring CCW (top view) with a screwdriver and inserting it in one of the notches located on the periphery of the spring adjuster. A tool S# 774B180G01 is available and is used to vary the spring tension through an opening in the front of the top surface of the molded bridge. By using this special tool, setting may be changed without removing the relay from its case.

Contact Gap – The gap between the stationary and moving contacts with the relay in the de-energized position should be approximately .030”.

7.2 OVERCURRENT UNIT (IT)

The pickup of the overcurrent unit should be within 10% of its setting.

7.3 INDICATING CONTACT SWITCH (ICS)

Close the main relay contacts and pass sufficient dc current through the trip circuit to close the contracts of the ICS. This value of current should be not less than 1.0 ampere nor greater than 1.2 amperes for the 1 ampere ICS. The current should not be greater than the particular ICS tap setting being used for the 0.2-2.0 ampere ICS. The operation indicator target should drop freely.

The contact gap should be approximately 0.047” for the 0.2/2.0 ampere unit and 0.070” for the 1.0 ampere unit between the bridging moving contact and the adjustable stationary contacts. The bridging moving contact should touch both stationary contacts simultaneously.

8.0 CALIBRATION

Use the following procedure for calibrating the relay if the relay has been taken apart for repairs or the adjustments have been disturbed. This procedure should not be used unless it is apparent that the relay is not in proper working order. (See “Acceptance Check” Section 7, this page).

Care should be used to avoid contact with the capacitors since high voltages may be present with the circuit energized.

8.1 TUNED CIRCUIT

If the capacitors, reactors, or overvoltage unit have been replaced, it may be necessary to retune the circuit. This can be accomplished using a regulated ac voltage with good sine wave. Initially set the adjustable reactor screws about 1/2 of their total travel. The screws may be adjusted without loosening the spring nuts.

Apply 75 volts (150V for the 150-400V range) ac to terminals 9 and 8 and adjust either screw for maximum current as measured by a milliammeter. This current should be less than 30 mA (42 mA for the 100-400V range). The two screws should be positioned approximately equal for the final adjustment.

After the above adjustment has been made it may be necessary to re-adjust the overvoltage unit spring for the desired operate voltage.

8.2 OVERVOLTAGE UNIT (V)

1. The upper bearing screw should be screwed down until there is approximately .025” clearance between it and the top of the shaft bearing. The upper pin bearing should then be securely locked in position with the lock nut.
2. The contact gap adjustment for the overcurrent unit is made with the moving contact in the reset position, i.e., against the right side of the bridge. Move in the left-hand stationary contact until it just touches the moving contact. Then back off the stationary contact one turn for a gap of approximately .030”. The clamp holding the stationary contact housing need not be loosened for the adjustment since the clamp utilizes a spring-type action in holding the stationary contact in

position.

3. The sensitivity adjustment is made by varying the tension of the spiral spring attached to the moving element assembly. The spring is adjusted by placing a screwdriver or tool Style number 774B180G01 into one of the notches located on the periphery of the spring adjuster and rotating it. The spring adjuster is located on the underside of the bridge and is held in place by a spring type clamp that does not have to be loosened prior to making the necessary adjustments.
4. Apply the desired pickup voltage and adjust the spring until the contacts just make. Voltages above 350 volts ac RMS should not be applied for more than 15 seconds at a time.

8.3 OVERCURRENT UNIT (IT)

Set the adjustable stationary contacts by inserting a .0125" thickness gauge between the armature and the core and adjust the stationary contacts until they just touch the moving contacts.

With the armature held against the core the contact wipe should be 1/64" to 3/64". Both contacts should make simultaneously.

8.4 INDICATING CONTACTOR SWITCH (ICS)

The contact gap should be approximately 0.047" for the 0.2/2.0 ampere unit and 0.070" for the 1.0 ampere unit between the bridging moving contact and the adjustable stationary contacts. The bridging moving contact should touch both stationary contacts simultaneously.

Close the main relay contacts and pass sufficient dc current through the trip circuit to close contacts of the ICS. This value of current should be not less than 1.0 ampere nor greater than 1.2 amperes for the 1 ampere ICS. The current should not be greater than the particular ICS tap setting being used for the 0.2-2.0 ampere ICS. The operation indicator target

should drop freely.

The varistor may be checked by passing 1 milliamp dc through it. Voltage across varistor should measure $900 \text{ Vdc} \pm 100\text{V}$.

9.0 ADJUSTMENTS & MAINTENANCE

The proper adjustments to insure correct operation of this relay have been made at the factory. Upon receipt of the relay, no customer adjustments, other than those covered under "Settings" should be required.

9.1 ROUTINE MAINTENANCE

All relays should be inspected periodically and the operation should be checked at least once every year or at such other time intervals as may be dictated by experience to be suitable to the particular application.

All contacts should be periodically cleaned. A contact burnisher Style number 182A836H01 is recommended for this purpose. The use of abrasive material for cleaning contacts is not recommended, because of the danger of embedding small particles in the face of the soft silver and thus impairing the contact.

10.0 RENEWAL PARTS

Repair work can be done most satisfactorily at the factory. However, interchangeable parts can be furnished to the customers who are equipped for doing repair work. When ordering parts, always give the complete nameplate data.

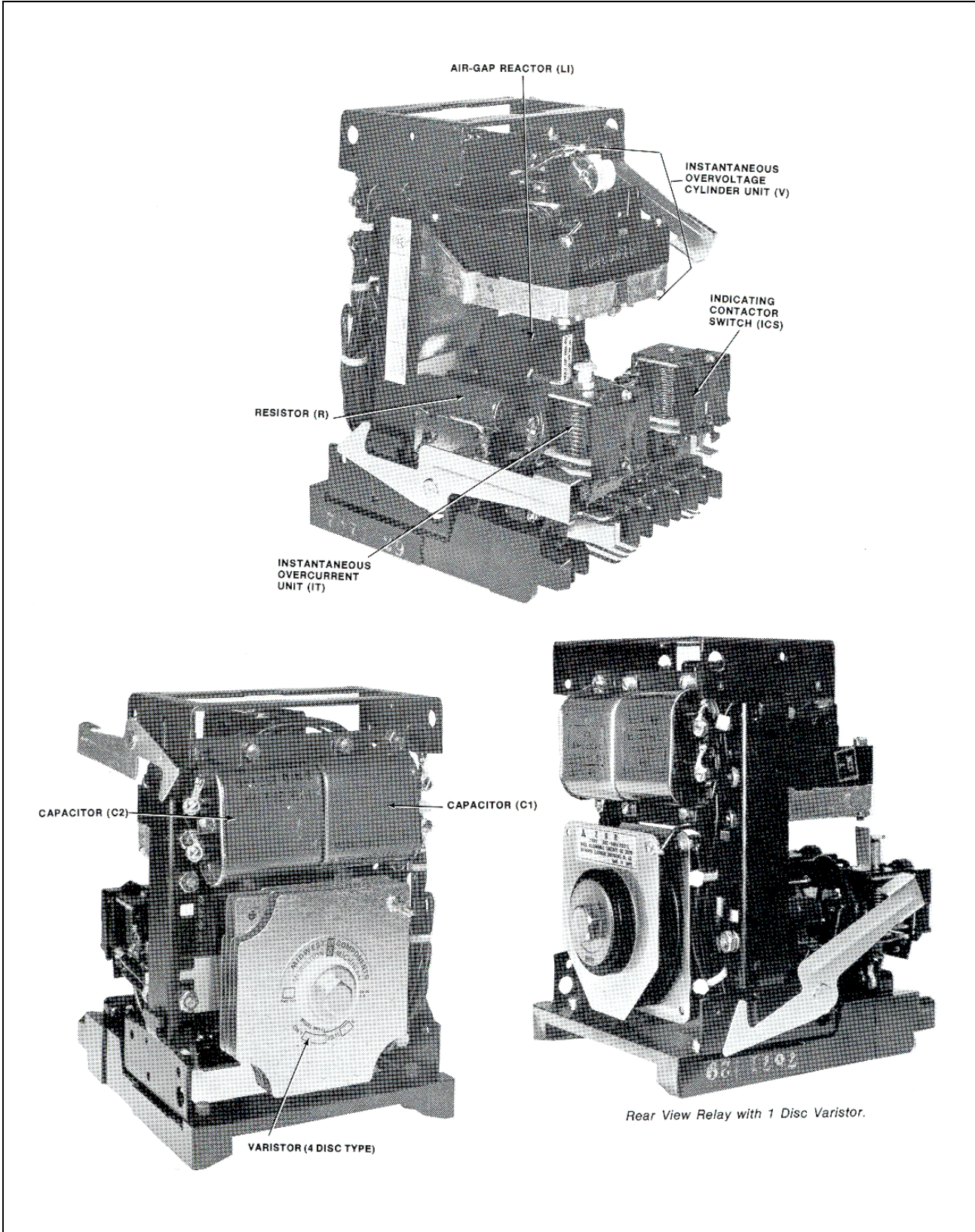

Figure 1. Type KAB Relay Without Case

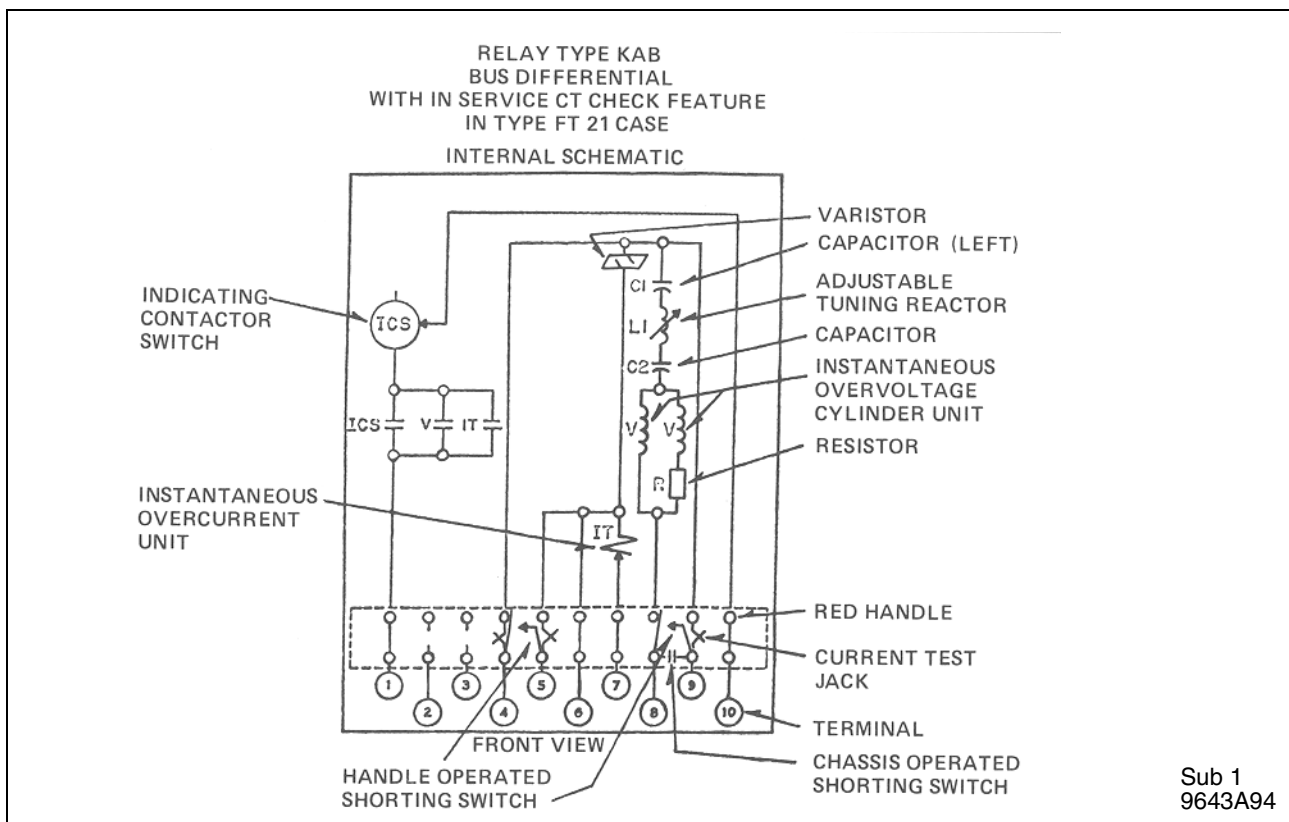

Figure 2. Internal Schematic Of KAB (150-400 Vac) Relay With In Service ct Check Feature.

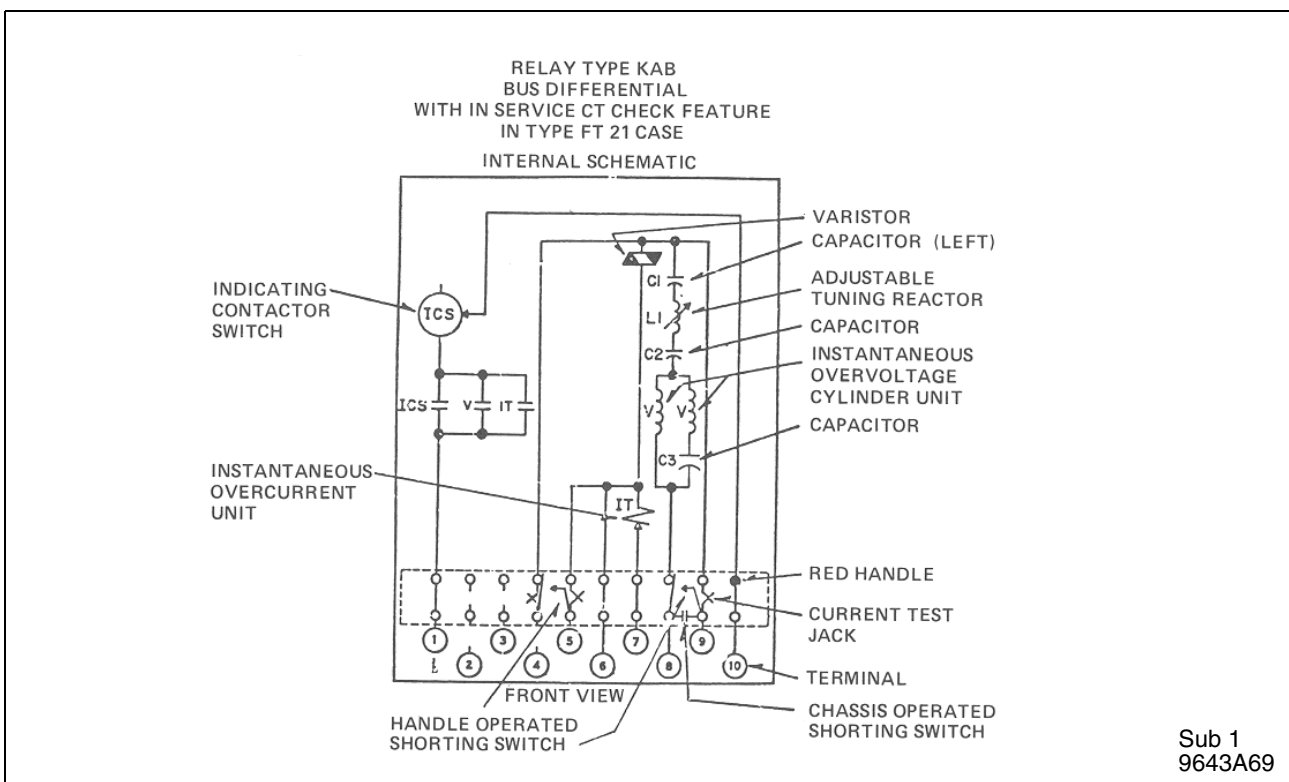

Figure 3. Internal Schematic of KAB Relay with in Service ct Check Feature. Pertains to all KAB Relay Styles 6668D37A04 and above (with IT unit).

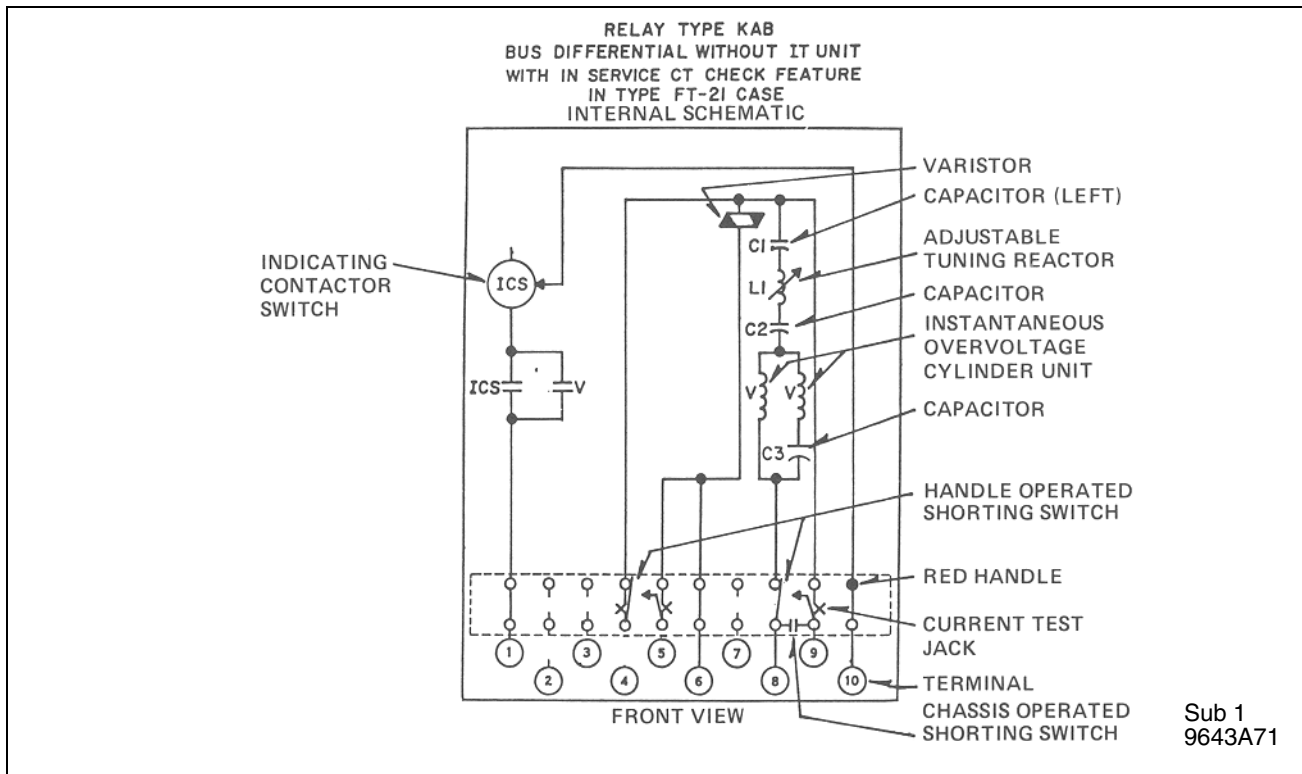

Figure 4. Internal Schematic of KAB Relay without instantaneous overcurrent unit and with in Service ct Check Feature. Pertains to all KAB Relay Style 6668D37A08 and above (without IT unit)

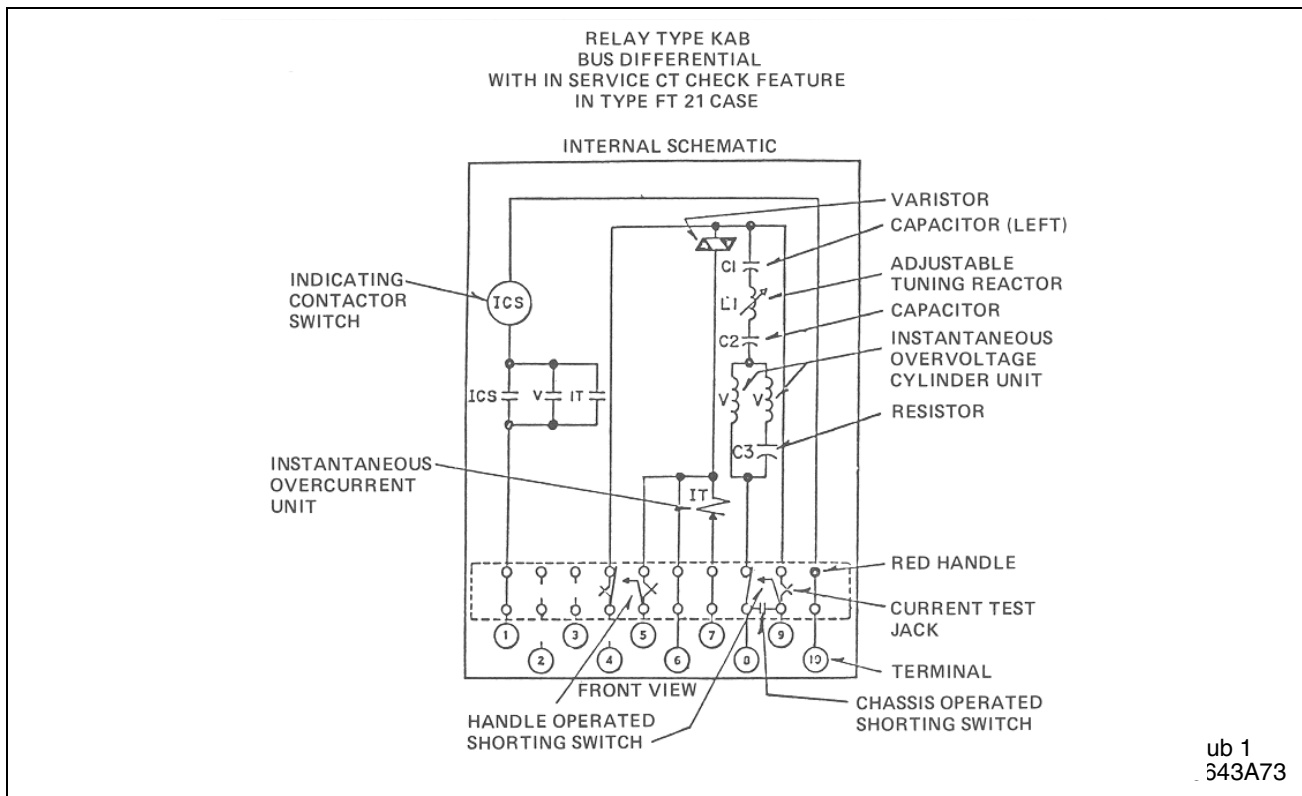

Figure 5. Internal Schematic of KAB RELAY with untapped ICS unit and with in service ct Check Feature.

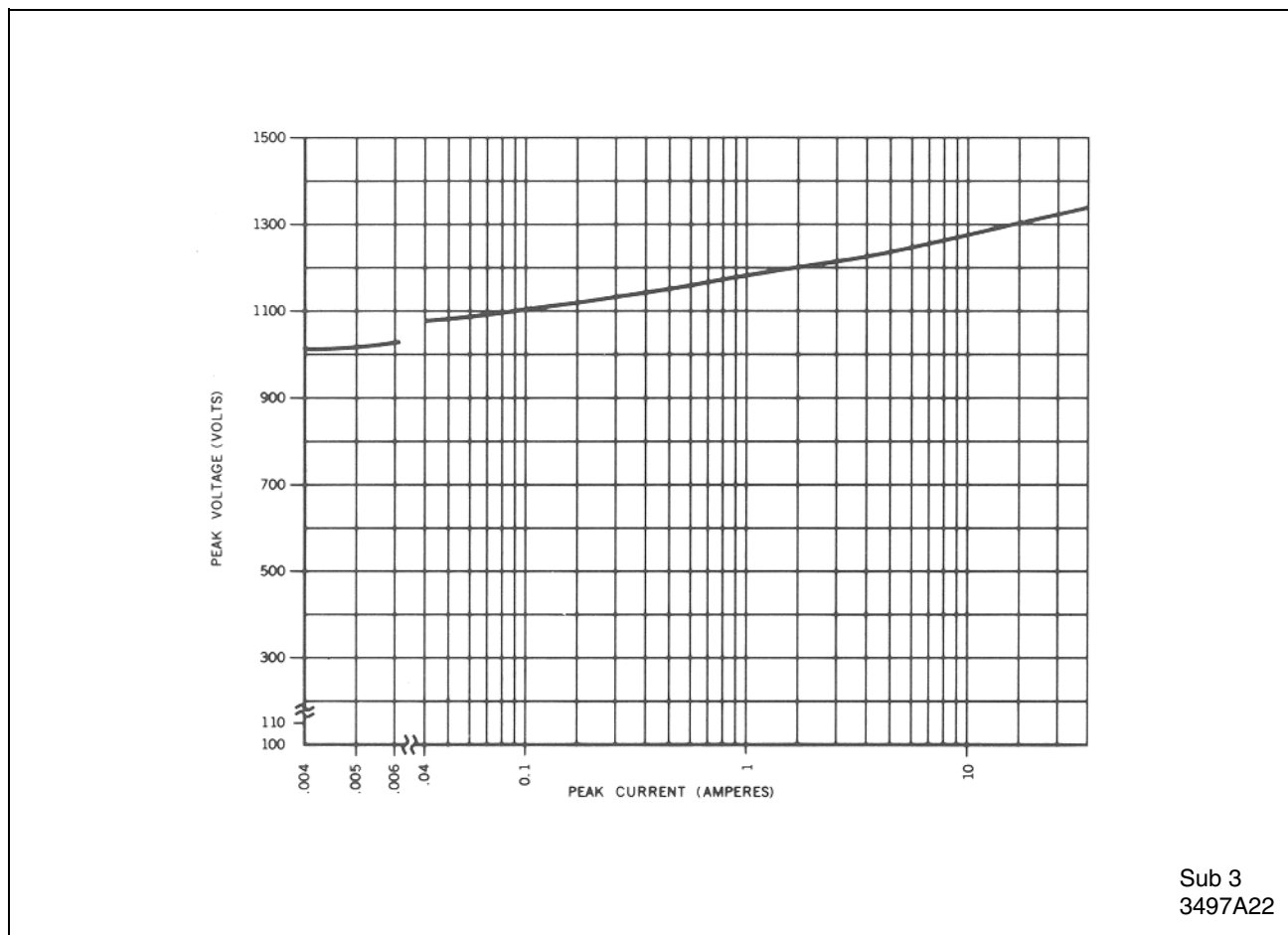

Figure 6. Typical Volt-Ampere Characteristic of Varistor in Type KAB Relay (Peak Value).

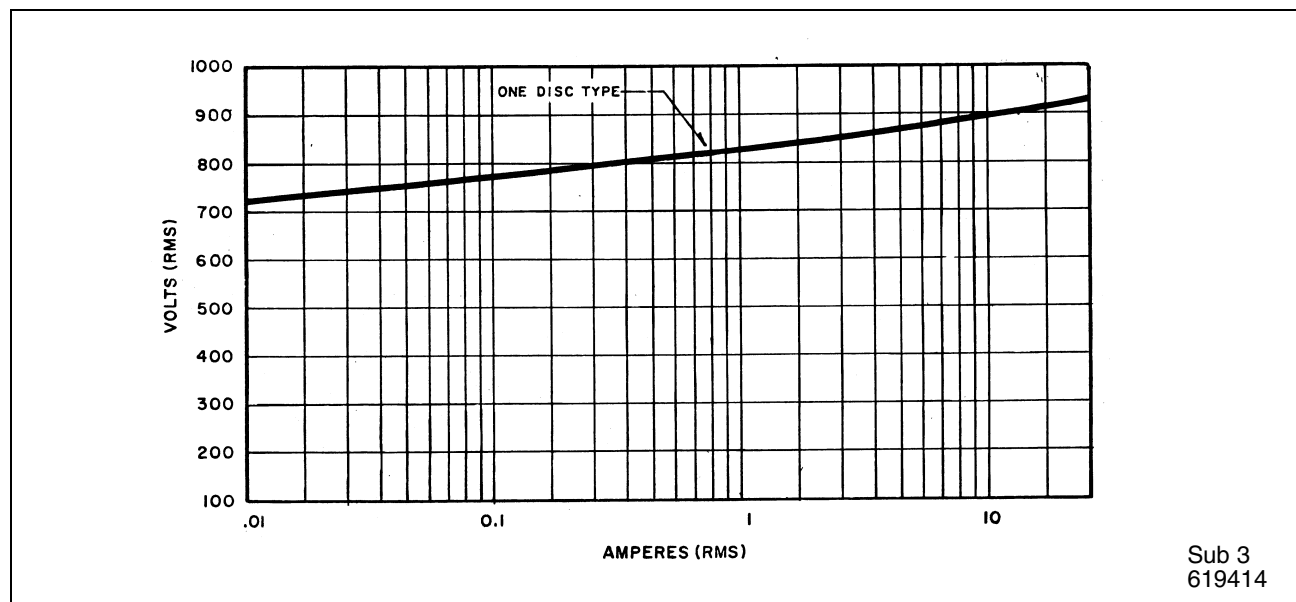

Figure 7. Typical Volt-Ampere Characteristic of Varistor in Type KAB Relay (RMS).

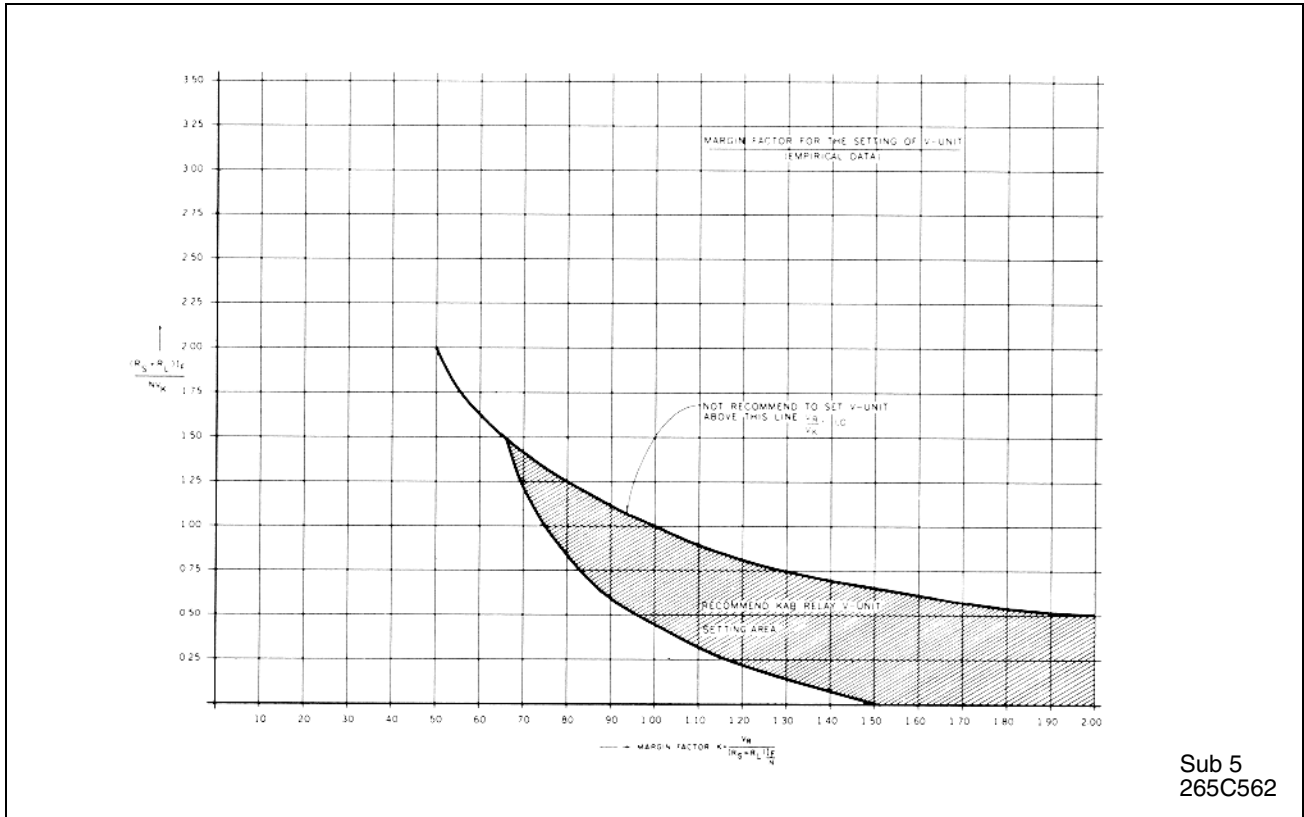

Figure 8. Margin Factor For V-Unit Setting.

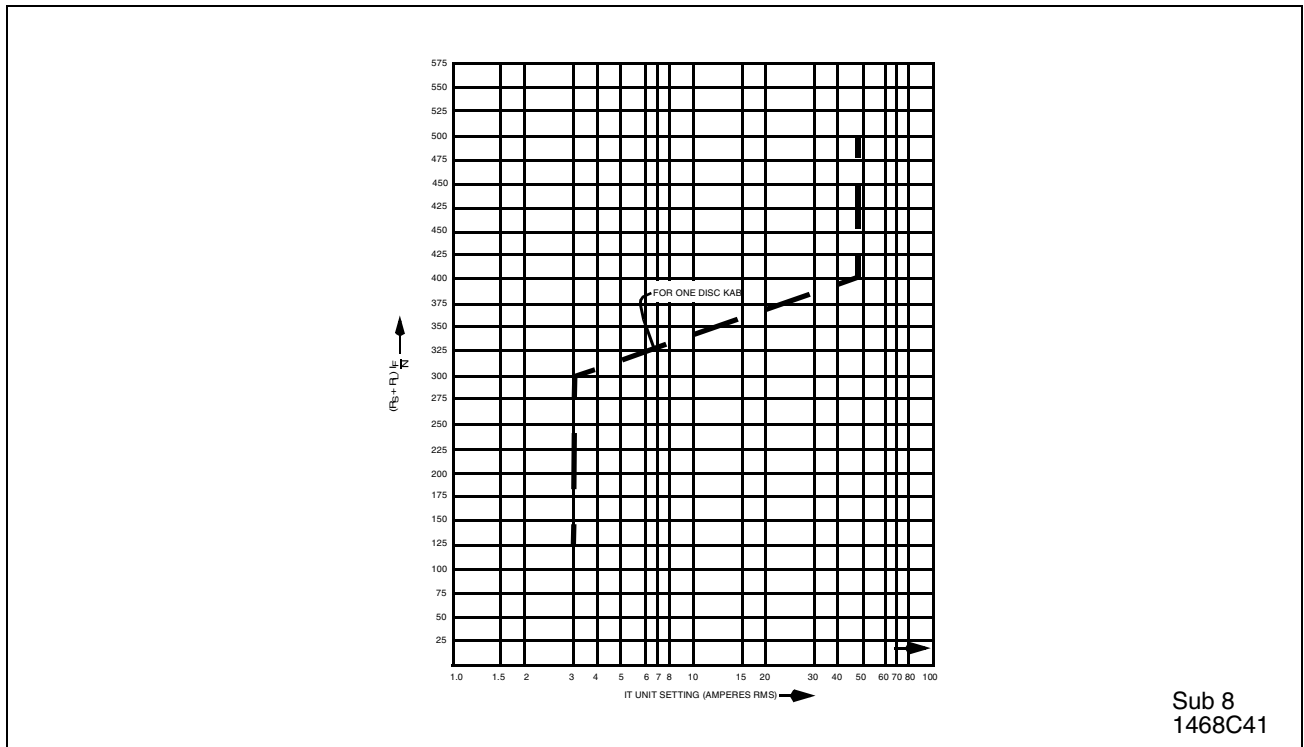
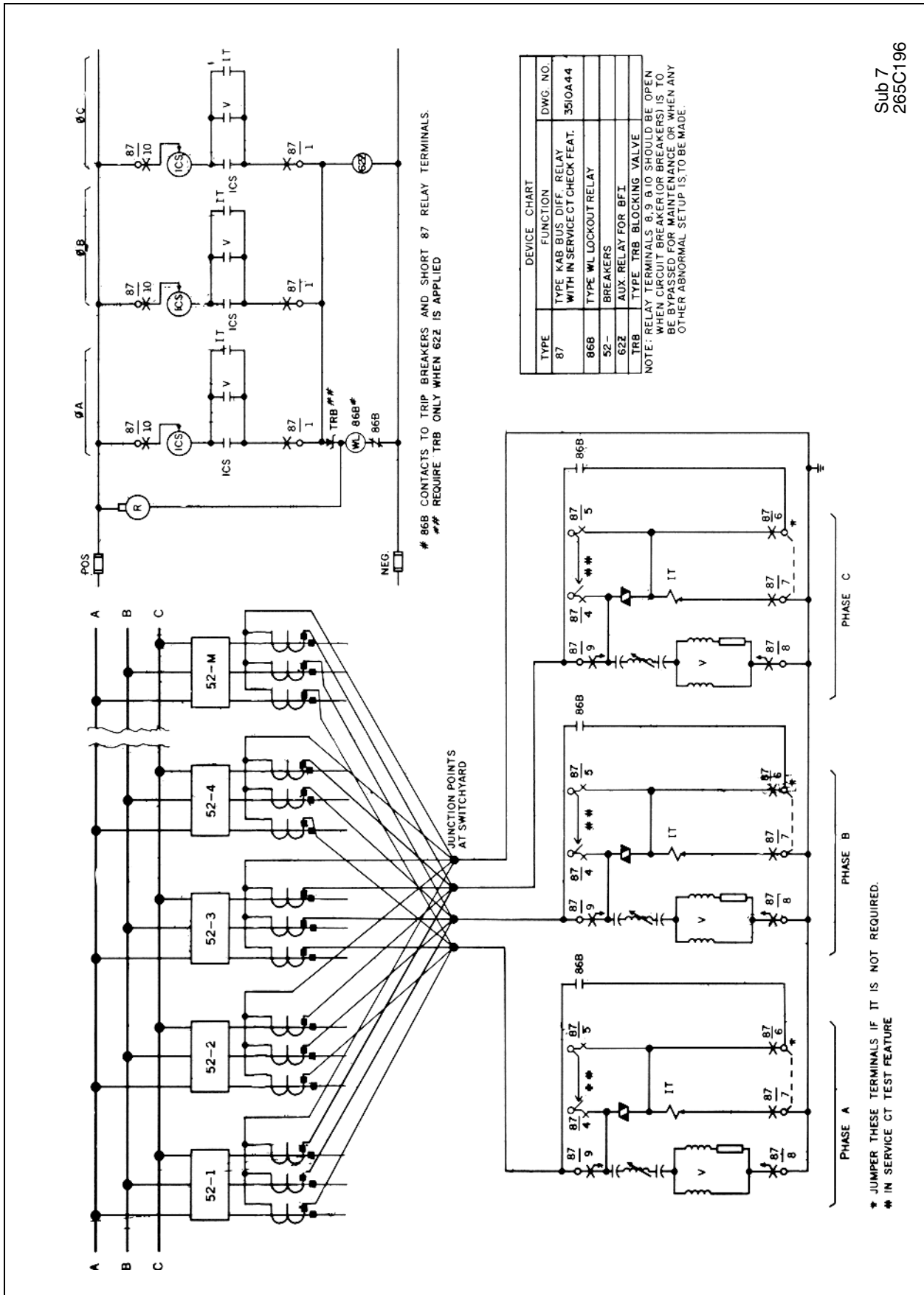

Figure 9. IT Unit Setting.



Sub 7
265C196

Figure 10. External Connections

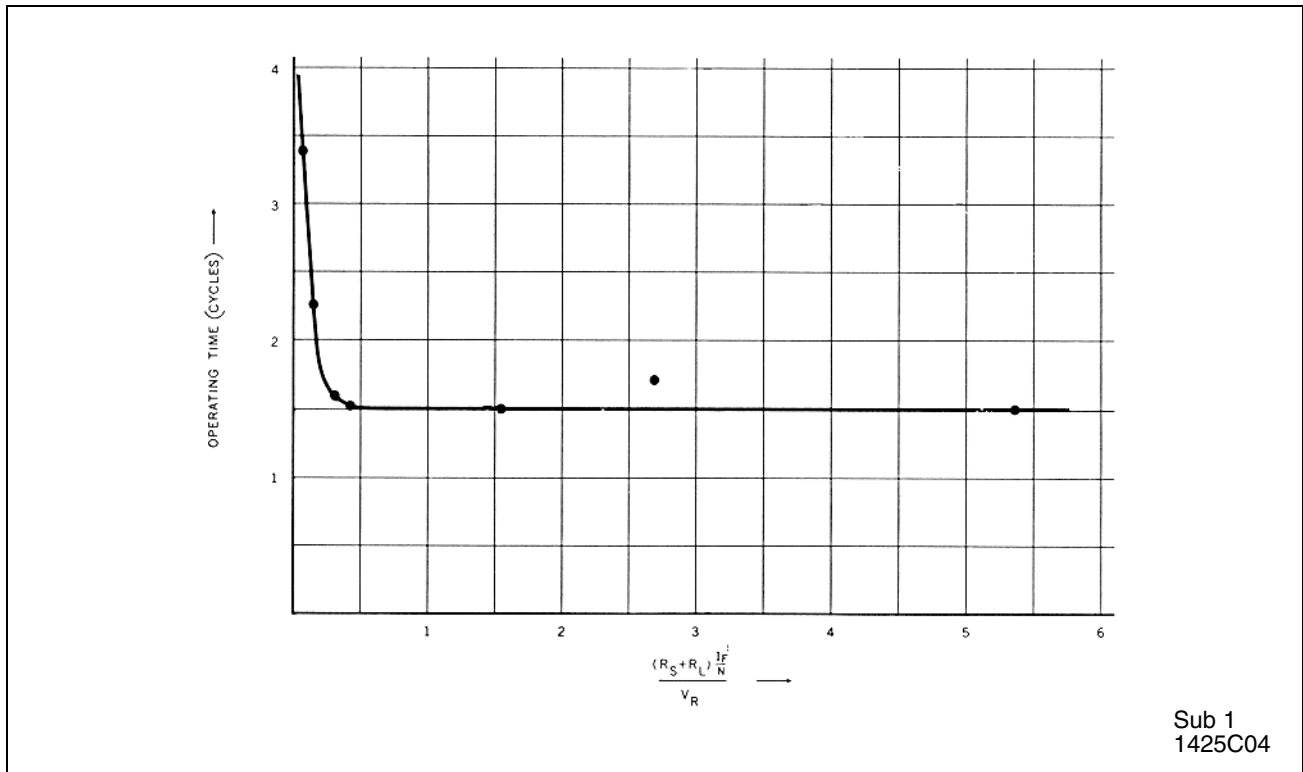

Figure 11. KAB Relay Typical Operating Time (from stage fault tests).

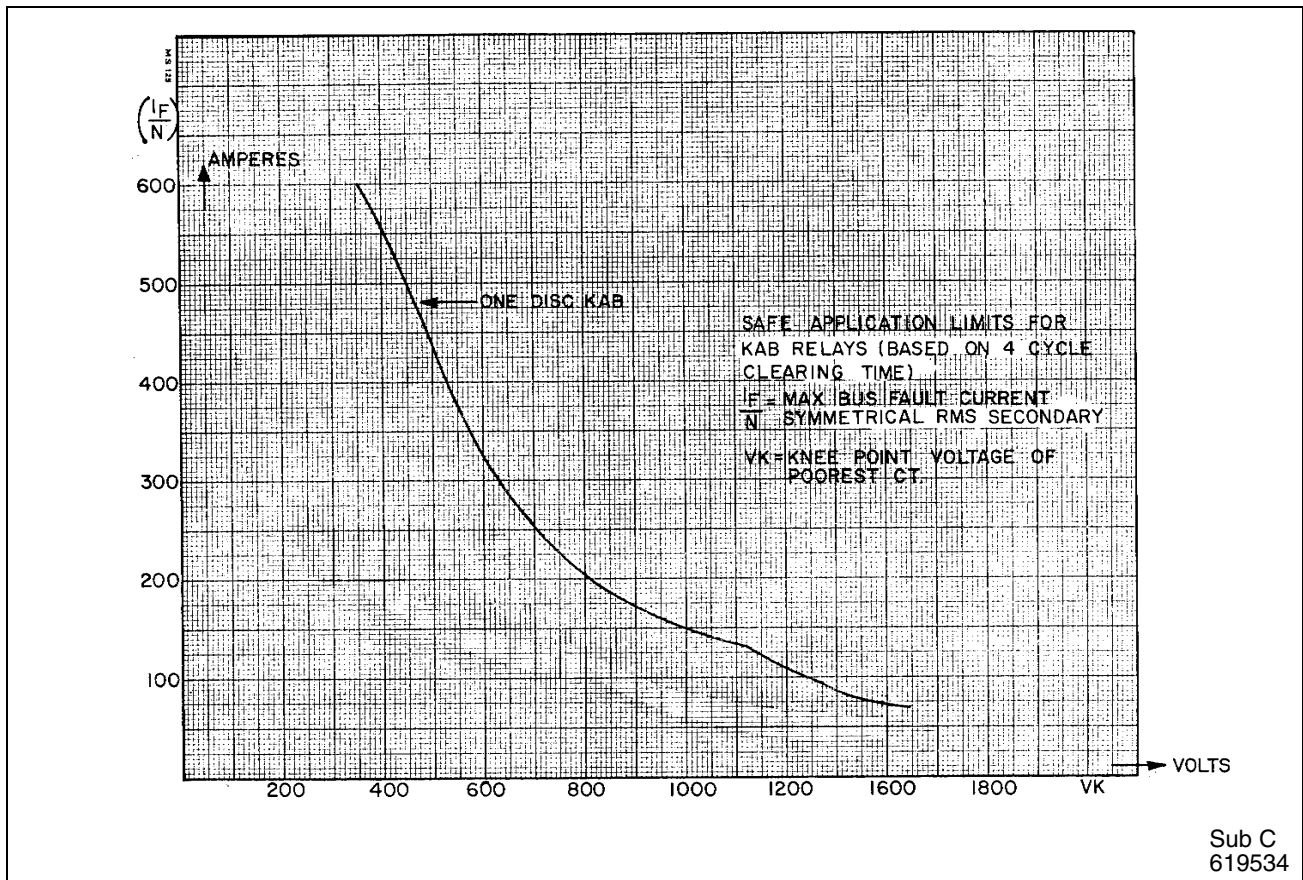

Figure 12. Safe Application Limits for KAB Relays.

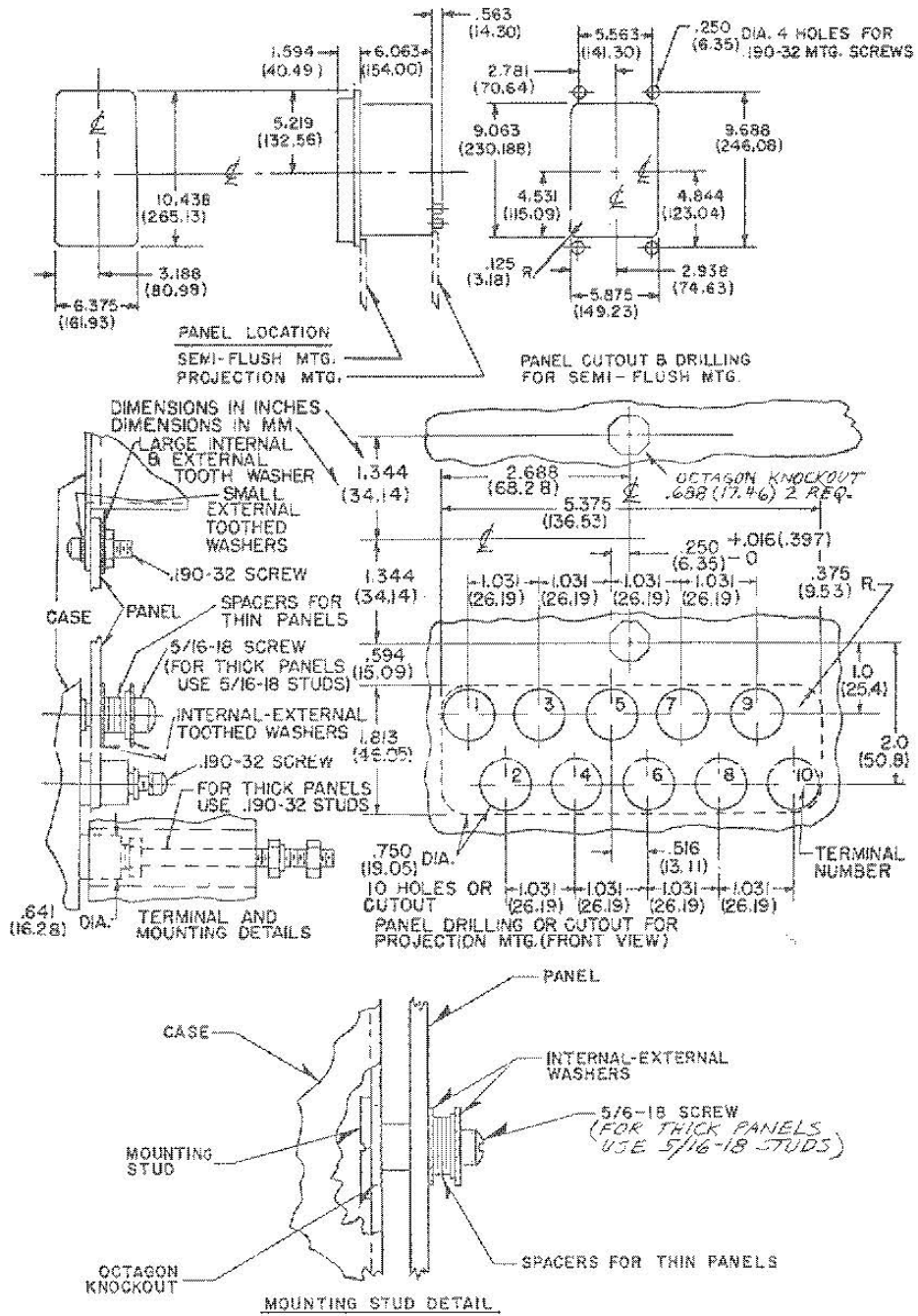

Figure 13. Outline and Drilling Plan For Type KAB Relay In Type FT-21 Case.

Sub 10
57D7901



ABB Inc.

4300 Coral Ridge Drive
Coral Springs, Florida 33065

Telephone: +1 954-752-6700

Fax: +1 954-345-5329

www.abb.com/substation_automation

IL 41-337.4 - Revision H