

An Introduction to Fluid Mechanics: Supplemental Web Appendices

Faith A. Morrison
Professor of Chemical Engineering
Michigan Technological University

November 5, 2013

Appendix C

Supplemental Mathematics Appendix

C.1 Multidimensional Derivatives

In section 1.3.1.1 we reviewed the basics of the derivative of single-variable functions. The same concepts may be applied to multivariable functions, leading to the definition of the partial derivative.

Consider the multivariable function $f(x, y)$. An example of such a function would be elevations above sea level of a geographic region or the concentration of a chemical on a flat surface. To quantify how this function changes with position, we consider two nearby points, $f(x, y)$ and $f(x + \Delta x, y + \Delta y)$ (Figure C.1). We will also refer to these two points as $f|_{x,y}$ (f evaluated at the point (x, y)) and $f|_{x+\Delta x, y+\Delta y}$.

In a two-dimensional function, the “rate of change” is a more complex concept than in a one-dimensional function. For a one-dimensional function, the rate of change of the function f with respect to the variable x was identified with the change in f divided by the change in x , quantified in the derivative, df/dx (see Figure 1.26). For a two-dimensional function, when speaking of the rate of change, we must also specify the direction in which we are interested. For example, if the function we are considering is elevation and we are standing near the edge of a cliff, the rate of change of the elevation in the direction over the cliff is steep, while the rate of change of the elevation in the opposite direction is much more gradual.

To quantify the change in the function $f(x, y)$ in an arbitrary direction, we define the differential df . Consider two nearby points (x, y) and $(x + \Delta x, y + \Delta y)$ and the associated

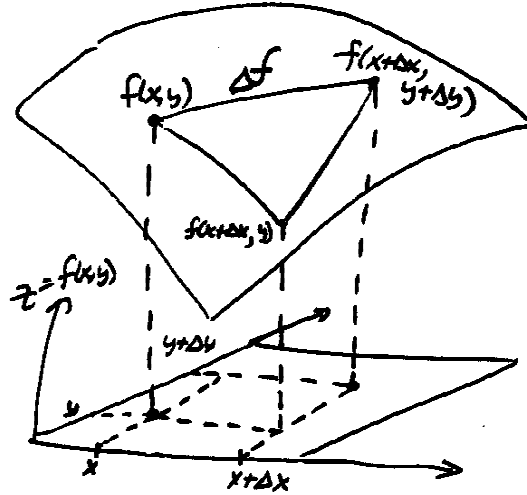

Figure C.1: A function of two variables $f(x, y)$ can be sketched as a surface. To quantify how the value of the function changes with position, we consider two nearby points, $f|_{x,y}$ and $f|_{x+\Delta x, y+\Delta y}$.

values of the function f at these two points. The differential df is defined as

$$df \equiv \lim_{\substack{\Delta x \rightarrow 0 \\ \Delta y \rightarrow 0}} \Delta f \quad (\text{C.1})$$

Differential
defined

$$df = \lim_{\substack{\Delta x \rightarrow 0 \\ \Delta y \rightarrow 0}} f(x + \Delta x, y + \Delta y) - f(x, y) \quad (\text{C.2})$$

We can further express df in terms of rates of change by breaking up the path from (x, y) to $(x + \Delta x, y + \Delta y)$ into two steps. Beginning at (x, y) we hold y constant and move a distance Δx in the x -direction. The function f changes as

$$\left(\begin{array}{c} \text{Change in } f \\ \text{holding } y \text{ constant} \end{array} \right) = f(x + \Delta x, y) - f(x, y) \quad (\text{C.3})$$

From this starting location, we now move a distance Δy in the y -direction, holding x constant. The function f changes as

$$\left(\begin{array}{c} \text{Change in } f \\ \text{holding} \\ x + \Delta x \text{ constant} \end{array} \right) = f(x + \Delta x, y + \Delta y) - f(x + \Delta x, y) \quad (\text{C.4})$$

The total change in f is just the sum of these two incremental changes.

$$\left(\begin{array}{c} \text{Total change} \\ \text{in } f \end{array} \right) = \left(\begin{array}{c} \text{Change in } f \\ \text{holding} \\ y \text{ constant} \end{array} \right) + \left(\begin{array}{c} \text{Change in } f \\ \text{holding} \\ x + \Delta x \text{ constant} \end{array} \right) \quad (\text{C.5})$$

$$\Delta f = f(x + \Delta x, y + \Delta y) - f(x, y) = [f(x + \Delta x, y) - f(x, y)] + [f(x + \Delta x, y + \Delta y) - f(x + \Delta x, y)] \quad (\text{C.6})$$

The two incremental changes that make up the total change in f can be related to derivatives in planes of constant y and x . For the first step, changing x at constant y , the situation is sketched in Figure C.2. This situation, with y held constant, reverts to the

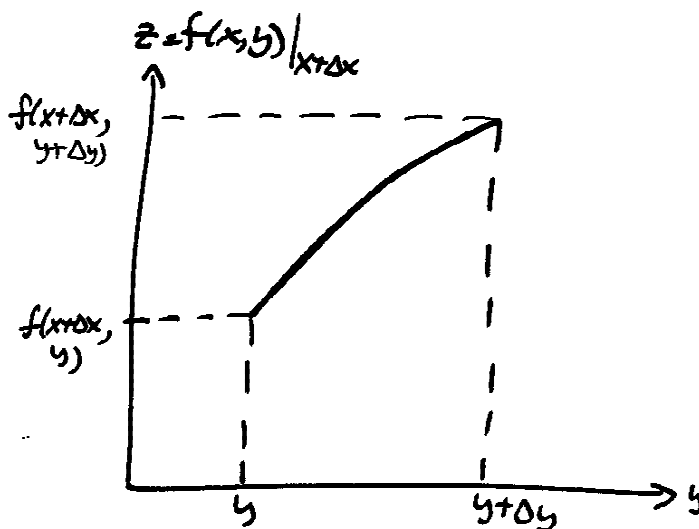

Figure C.2: The total change in f may be broken into first a change in x and subsequently a change in y . For the first of these two steps the function f changes as shown in this figure.

classical situation of a single-variable function. The rate of change of f can be related to a derivative. Because we must specify that y is held constant, we define a new derivative, the partial derivative.

$$\text{slope} = \frac{\text{rise}}{\text{run}} \quad (\text{C.7})$$

$$\left(\frac{\partial f}{\partial x} \right)_y \equiv \left(\frac{\text{rise}}{\text{run}} \right)_{y \text{ held constant}} \quad (\text{C.8})$$

$$\text{Partial derivative defined} \quad \boxed{\left(\frac{\partial f}{\partial x} \right)_y = \lim_{\Delta x \rightarrow 0} \frac{f(x + \Delta x, y) - f(x, y)}{\Delta x}} \quad (\text{C.9})$$

For the second step, changing y at constant $x + \Delta x$, the situation is sketched in Figure C.3. This situation, with $x + \Delta x$ held constant, allows us to write the partial derivative

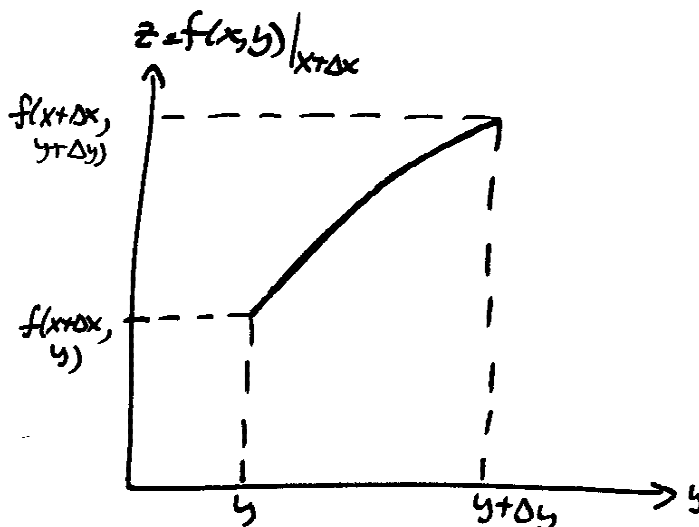

Figure C.3: The second part of the total change in f is a change in y at constant $x + \Delta x$, as shown in this figure.

with respect to y using an expression analogous to equation C.9.

$$\left(\frac{\partial f}{\partial y}\right)_{x+\Delta x} = \left(\frac{\text{rise}}{\text{run}}\right)_{x+\Delta x \text{ held constant}} \quad (\text{C.10})$$

$$\left(\frac{\partial f}{\partial y}\right)_{x+\Delta x} = \lim_{\Delta y \rightarrow 0} \frac{f(x + \Delta x, y + \Delta y) - f(x + \Delta x, y)}{\Delta y} \quad (\text{C.11})$$

The two expressions for partial derivative that we have developed, equation C.9 and equation C.11, may now be combined with the equation for the total differential df (equation C.6). The final step in our development is to take the limits as Δx and Δy go to zero.

$$\Delta f = f(x + \Delta x, y + \Delta y) - f(x, y) = [f(x + \Delta x, y) - f(x, y)] + [f(x + \Delta x, y + \Delta y) - f(x + \Delta x, y)] \quad (\text{C.12})$$

$$\Delta f = \left(\frac{\partial f}{\partial x}\right)_y \Delta x + \left(\frac{\partial f}{\partial y}\right)_{x+\Delta x} \Delta y \quad (\text{C.13})$$

Taking the limit as both Δx and Δy go to zero we obtain the final expression for the total

differential df .

$$df \equiv \lim_{\substack{\Delta x \rightarrow 0 \\ \Delta y \rightarrow 0}} \Delta f \quad (\text{C.14})$$

$$df = \left(\frac{\partial f}{\partial x} \right)_y dx + \left(\frac{\partial f}{\partial y} \right)_x dy \quad (\text{C.15})$$

The result in equation C.15 may be extended to functions of more than two variables. For example, for the four-dimensional function $f(x_1, x_2, x_3, t)$, df becomes

$$df = \left(\frac{\partial f}{\partial x_1} \right)_{x_2, x_3, t} dx_1 + \left(\frac{\partial f}{\partial x_2} \right)_{x_1, x_3, t} dx_2 + \left(\frac{\partial f}{\partial x_3} \right)_{x_1, x_2, t} dx_3 + \left(\frac{\partial f}{\partial t} \right)_{x_1, x_2, x_3} dt \quad (\text{C.16})$$

This is often written more compactly as shown below, with the understanding that the appropriate variables are held constant during each partial differentiation.

$$df = \frac{\partial f}{\partial x_1} dx_1 + \frac{\partial f}{\partial x_2} dx_2 + \frac{\partial f}{\partial x_3} dx_3 + \frac{\partial f}{\partial t} dt \quad (\text{C.17})$$

C.2 Multidimensional Integrals

In section 1.3.1.2 we reviewed the basics of the integral. In this appendix we expand this background material into two and three dimensions.

C.2.1 Double Integrals

Double integrals are defined as summations over two dimensions, for example, x and y . These types of integrals can be useful in calculating surface areas, volumes, and flow rates through surfaces, as well as other quantities.

C.2.1.1 Enclosed Area

One use of the single integral of section 1.3.1.2 was to calculate area, specifically area under a curve, but the single-integral technique is not appropriate for calculating every type of area. Consider, for example, the area in a plane bounded by a closed curve (Figure C.4). Looking back at equation 1.151, in the single-integral method we calculated area under a curve by summing the areas of rectangles constructed from values of $f(x_i)$ multiplied by the interval Δx . In the case of the area bounded by a closed curve (Figure C.4), the product $f(x_i)\Delta x$ does not give a piece of the desired area. Thus the single-integral method does not give us the quantity we seek.

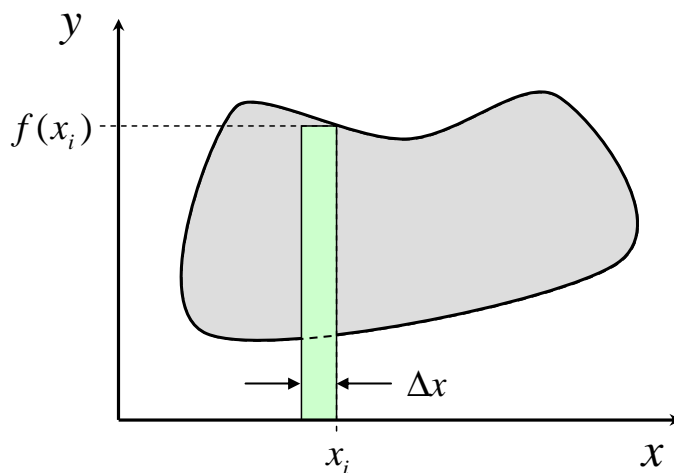

Figure C.4: One interpretation of the single integral is as area under a curve. This interpretation is not helpful in finding enclosed area such as is shown here. The area elements that are summed to give area under a curve (single integral) do not correspond to a meaningful contribution to an enclosed area.

We can define a new type of integral that is suitable for this new problem. The area bounded by a closed curve can be approximated by the sum of the areas $\Delta x \Delta y$, where Δx and Δy are small intervals in the Cartesian coordinates of the plane (Figure C.5). The sizes of Δx and Δy are arbitrary, just as the size of Δx was arbitrary in equation 1.151. The key feature is that as Δx and Δy are made smaller, the area approximation becomes better, and in the limit $\Delta x \rightarrow 0$, $\Delta y \rightarrow 0$, we obtain the area we seek.

We now set out to define the double integral. Consider R , an area in a plane bounded by a closed curve (Figure C.5). We first construct a grid by choosing initial sizes Δx and Δy and divide up the plane into rectangles of area $\Delta x \Delta y$. The grid we construct produces rectangles that are wholly within the closed curve, rectangles that are wholly outside of the closed curve, and some rectangles that intersect the boundary. We will only count the rectangles that are wholly inside the bounding curve.

We now sum up the areas of the rectangles $\Delta x \Delta y$ that are wholly within the closed curve.

$$\text{Area} \approx \sum_{i=1}^N [\Delta x \Delta y]_i \quad (\text{C.18})$$

$$= \sum_{i=1}^N \Delta A_i \quad (\text{C.19})$$

where N is the number of rectangles within the bounded region, and $\Delta A_i = [\Delta x \Delta y]_i$. We define the double integral to be the limit of this sum as the dimensions Δx and Δy go to

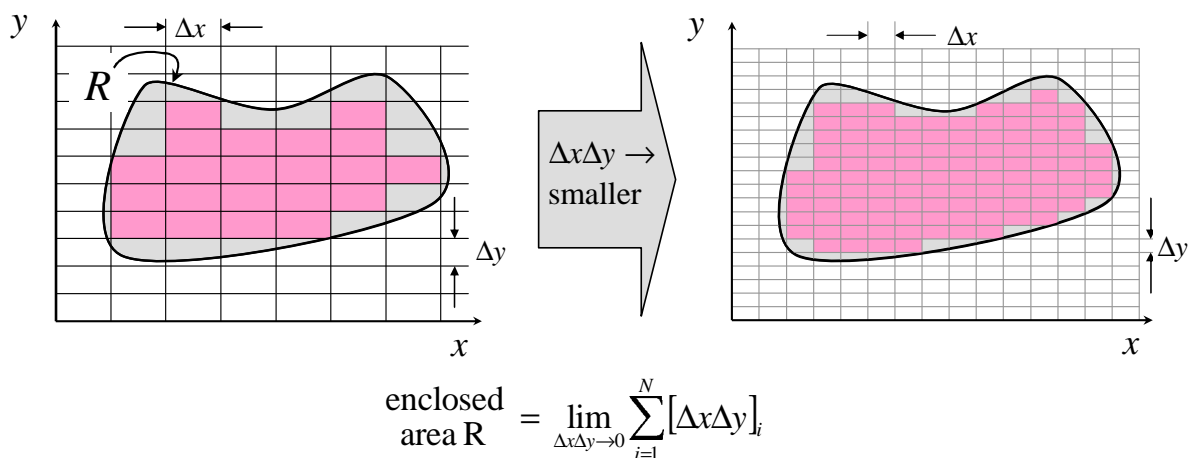

Figure C.5: The area inside a closed curve may be calculated by dividing up coordinate space and adding up the areas of enclosed rectangles $\Delta x \Delta y$. As $\Delta x \Delta y$ goes to zero, the correct area is obtained.

zero. The double integral is equal to the bounded area.

Enclosed area in a plane
or Double Integral
(version 1) defined

$$I = \iint_{\mathcal{R}} dA \equiv \lim_{\Delta A \rightarrow 0} \left[\sum_{i=1}^N \Delta A_i \right] \quad (\text{C.20})$$

The techniques used to evaluate double integrals may be found in standard calculus texts[185].

Note that when we defined the single integral, one use was to calculate area (area under a curve) and now we see that the double integral is used to calculate area as well (enclosed area). We will see that to calculate volume, we must sometimes use a double integral (section C.2.1.2) and sometimes a triple integral (section C.2.2.1). The factor that determines what type of integral to use is the definition of the quantity of interest. We always begin with the definition, and subsequently we develop a limit of a summation that leads us to the appropriate type of integral.

We can illustrate the use of equation C.20 with an example.

EXAMPLE C.1 *What is the area enclosed by a circle of radius R ?*

SOLUTION This is a problem from elementary geometry, and the solution

is πR^2 . This result can be calculated in cylindrical coordinates as follows.

$$\text{Area of circle} = \int_S dS = \int_0^R \int_0^{2\pi} r \, dr d\theta \quad (\text{C.21})$$

$$= 2\pi \left. \frac{r^2}{2} \right|_0^R = \pi R^2 \quad (\text{C.22})$$

$$(\text{C.23})$$

This calculation was straightforward because we could easily write dS in the cylindrical coordinate system.

For shapes that are irregular or unusual, we must apply more thought to the process. We will not use the cylindrical coordinate system; we will carry out our integration in the cartesian systems shown in Figure C.6.

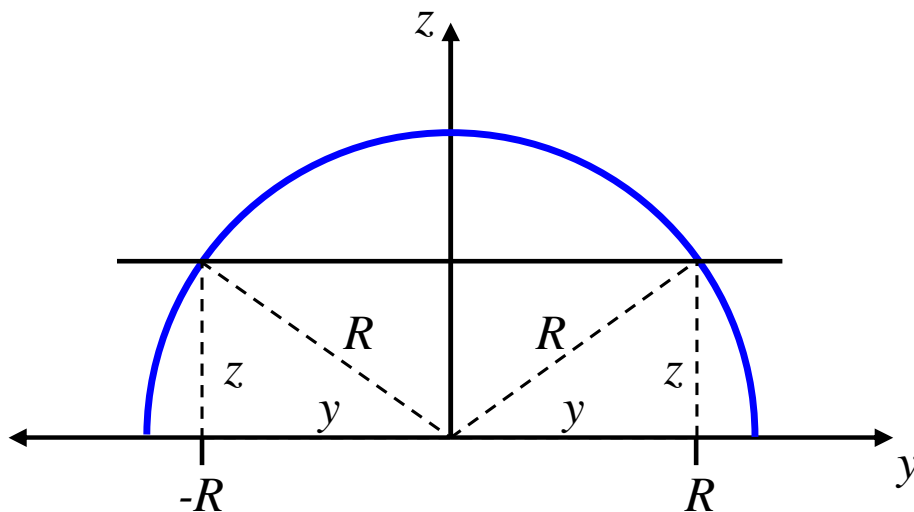

Figure C.6: We can calculate the area of a circle using general methods and a cartesian coordinate system as described in the text.

To calculate the area of a circle, we will divide it in half, perform a double integral over the half circle, and double the result. We begin with equation C.20.

$$\text{Area enclosed by half circle} = \iint_{\mathcal{R}} dA \quad (\text{C.24})$$

The differential dA in our cartesian system is $dydz$. The only remaining step is to determine the limits of the integration, which are related to the equation for the circle.

$$\text{Equation for circle} \quad R^2 = y^2 + z^2 \quad (\text{C.25})$$

The variable z goes from zero to a maximum at $z = R$. As z varies, the limits between which y varies change. If we draw a horizontal line at an arbitrary value of z , we see that the limits on the coordinate y are from $y = -\sqrt{R^2 - z^2}$ to $y = +\sqrt{R^2 - z^2}$. Thus the integral becomes

$$\begin{aligned} \text{Area enclosed} &= \iint_{\mathcal{R}} dA \\ \text{(by half circle)} & \end{aligned} \quad (C.26)$$

$$= \int_0^R \int_{-\sqrt{R^2 - z^2}}^{+\sqrt{R^2 - z^2}} dy dz \quad (C.27)$$

Carrying out this integral we obtain the final result.

$$\begin{aligned} \text{Area enclosed} &= \int_0^R \int_{-\sqrt{R^2 - z^2}}^{+\sqrt{R^2 - z^2}} dy dz \\ \text{by half circle} & \end{aligned} \quad (C.28)$$

$$= \int_0^R \left(y \Big|_{-\sqrt{R^2 - z^2}}^{+\sqrt{R^2 - z^2}} \right) dz \quad (C.29)$$

$$= \int_0^R 2\sqrt{R^2 - z^2} dz \quad (C.30)$$

$$= 2 \left[\frac{1}{2} \left(z\sqrt{R^2 - z^2} + R^2 \sin^{-1} \frac{z}{R} \right) \right] \Big|_0^R \quad (C.31)$$

$$= \frac{\pi R^2}{2} \quad (C.32)$$

Thus, the area for a complete circle is twice this result or πR^2 , as expected. No special coordinate system was required for this calculation; we needed to know only the equations of the boundary, which determine the limits of the integration.

C.2.1.2 Volume

There are many other quantities that are calculated as limits of two-dimensional sums similar to equation C.20. One example is the calculation of volume, specifically the volume V of the solid region V bordered by a function $z = f(x, y)$ and the domain in the xy plane over which $f(x, y)$ is defined.

Consider the solid shown in Figure C.7. The base of the solid V is the surface R in the xy plane. First we divide R into sub-areas $\Delta x \Delta y = \Delta A$ as before. For the i^{th} area ΔA_i , $f(x_i, y_i)$ is a value of the function $f(x, y)$ evaluated at any point (x_i, y_i) within ΔA_i . Then the quantity $f(x_i, y_i) \Delta A_i$ represents the volume of a vertical rectangular prism that

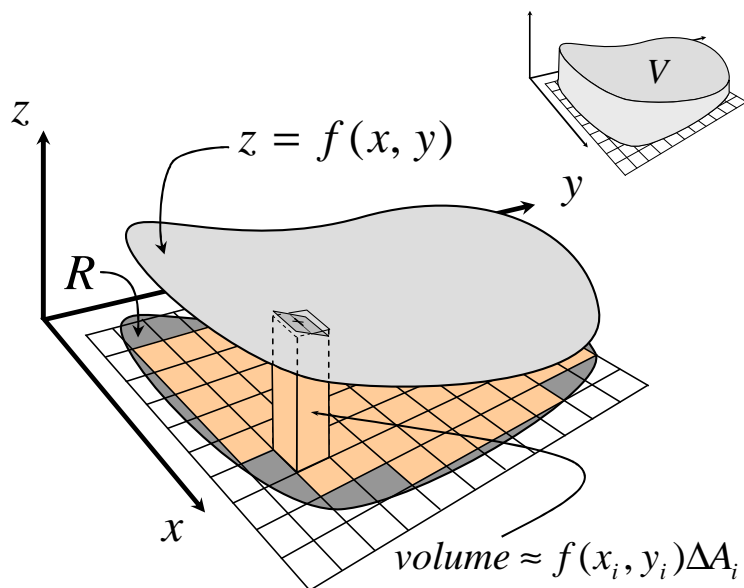

Figure C.7: A double integral may be used to calculate the volume of the solid region bordered by a function $z = f(x, y)$ and the domain in the xy plane over which $f(x, y)$ is defined.

approximates the volume of the portion of V that stands directly above ΔA_i .

$$\begin{array}{l} \text{Volume between} \\ \text{the upper surface } f(x, y) \\ \text{and } \Delta A_i \text{ in the } xy \text{ plane} \end{array} \approx f(x_i, y_i)\Delta A_i \quad (\text{C.33})$$

The total volume of the solid V is then approximated by the sum of these contributions, counting only the areas ΔA_i that are wholly within R .

$$\begin{array}{l} \text{Volume between} \\ \text{the upper surface } f(x, y) \\ \text{and } R \text{ in the } xy \text{ plane} \end{array} \approx \sum_{i=1}^N f(x_i, y_i)\Delta A_i \quad (\text{C.34})$$

The true volume of the solid is given by the limit of this summation as Δx and Δy go to zero.

$$\begin{array}{l} \text{Volume between} \\ \text{the upper surface } f(x, y) \\ \text{and } R \text{ in the } xy \text{ plane} \end{array} = \lim_{\Delta A \rightarrow 0} \left[\sum_{i=1}^N f(x_i, y_i)\Delta A_i \right] \quad (\text{C.35})$$

where as before $\Delta A_i = [\Delta x \Delta y]_i$. The limit of the sum in equation C.35 is defined as the

double integral of the function $f(x, y)$ over R .

Double Integral
of a function
(general version)

$$I = \iint_{\mathcal{R}} f(x, y) dA \equiv \lim_{\Delta A \rightarrow 0} \left[\sum_{i=1}^N f(x_i, y_i) \Delta A_i \right] \quad (\text{C.36})$$

Volume between
the upper surface $f(x, y)$
and R in the xy plane

$$= \iint_{\mathcal{R}} f(x, y) dA \quad (\text{C.37})$$

Note that the definition of double integral above (equation C.36) reduces to the definition of double integral we made earlier (equation C.20) when the function $f(x, y)$ is taken to be $f(x, y) = 1$.

C.2.1.3 Mass Flow Rate

The double integral is a quantity that can have meanings other than area (equation C.20) or volume (equation C.37). For example, in fluid mechanics we often need to calculate the total mass flow rate through a flat surface (Figure C.8). Consider the flow through the flat

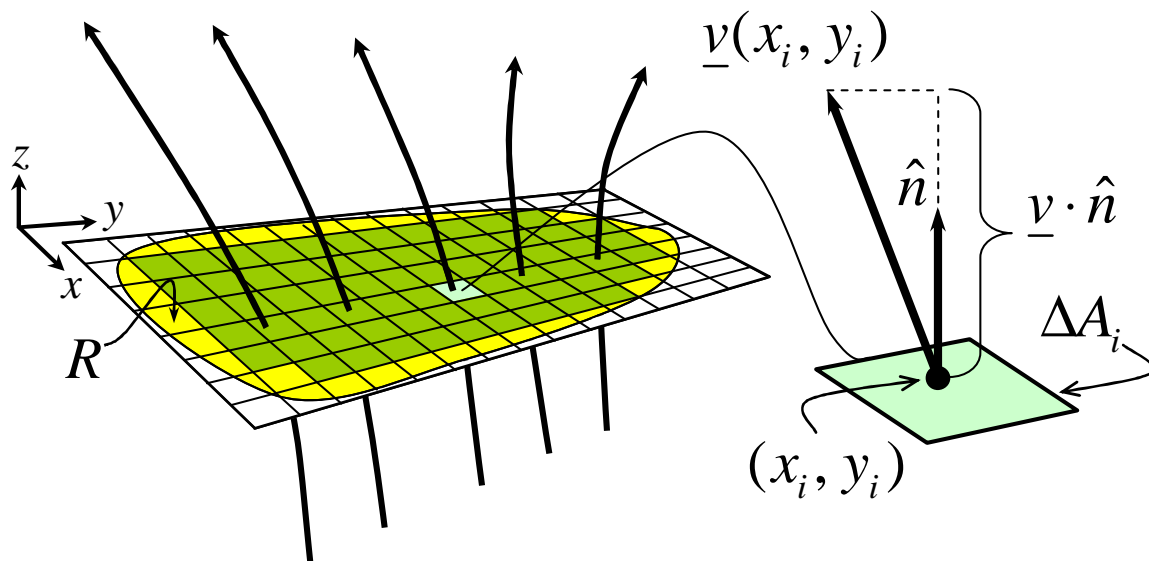

Figure C.8: The double integral allows us to calculate the mass flow rate through a flat surface. In locations where the velocity is not perpendicular to the surface, only the component of velocity perpendicular to the surface contributes to mass flow through the surface.

surface R shown in Figure C.8. The fluid velocity $\underline{v}(x, y)$ is a vector function of position, and the fluid density $\rho(x, y)$ is a scalar function of position. We seek to calculate the mass flow rate through the surface R . If we divide R into rectangles ΔA as before, we can approximate the mass flow rate through R as the sum of the mass flow rates through the individual areas ΔA_i . In the limit that ΔA goes to zero, the error in this approximation goes to zero, and this sum becomes the total mass flow rate through R . Note that in the current case of a flat surface R , the unit normal to the surface $\hat{n} = \hat{e}_z$ is independent of position.

$$\begin{aligned} \text{Mass flow rate} \\ \text{through the } i^{\text{th}} \\ \text{rectangle } \Delta A_i \end{aligned} &= \left(\frac{\text{mass}}{\text{volume}} \right) \left(\frac{\text{volume flow}}{\text{time}} \right) \quad (\text{C.38})$$

$$= \rho(x_i, y_i) (\underline{v}(x_i, y_i) \cdot \hat{n}) \Delta A_i \quad (\text{C.39})$$

The quantity $\underline{v} \cdot \hat{n}$ is used in the expression for the volume flow per unit time above (rather than \underline{v}) since only the component of velocity perpendicular to the surface contributes to the flow across the surface (Figure C.8).

We now sum over all rectangles ΔA_i that are fully contained within R and subsequently take the limit as ΔA becomes small.

$$\begin{aligned} \text{Mass flow rate} \\ \text{through } R \end{aligned} \approx \sum_{i=1}^N \rho(x_i, y_i) (\underline{v}(x_i, y_i) \cdot \hat{n}) \Delta A_i \quad (\text{C.40})$$

$$\begin{aligned} \text{Mass flow rate} \\ \text{through } R \end{aligned} = \lim_{\Delta A \rightarrow 0} \left[\sum_{i=1}^N \rho(x_i, y_i) (\underline{v}(x_i, y_i) \cdot \hat{n}) \Delta A_i \right] \quad (\text{C.41})$$

Comparing equation C.41 to the definition of double integral in equation C.36 we see that the total mass flow through R is given by a double integral over the function $f(x, y) = \rho \underline{v} \cdot \hat{n}$.

$$\begin{aligned} \text{Mass flow rate} \\ \text{through} \\ \text{flat surface } R \end{aligned} = \iint_{\mathcal{R}} \rho \underline{v} \cdot \hat{n} \, dA \quad (\text{C.42})$$

In fluid mechanics we are also interested in flows through curved surfaces (Figure C.9). With some adjustments, our previous strategy for calculating mass flow through a flat surface should work on this new problem: divide up the surface, write the mass flow for each piece of surface, sum up these contributions to obtain the total mass flow rate. In the case of a curved surface, dividing up the surface is tricky, since the surface has a complex shape (in general). We will need to be systematic.

Our approach will be to project S , the three-dimensional surface area of interest, onto a plane we will call the xy plane (Figure C.10). The area of the projection will be R . Since R is in the xy plane, the unit normal to R is \hat{e}_z . We divide the projection R the way we did in the previous calculation, into areas $\Delta A = \Delta x \Delta y$ and seek to write the mass flow rate in

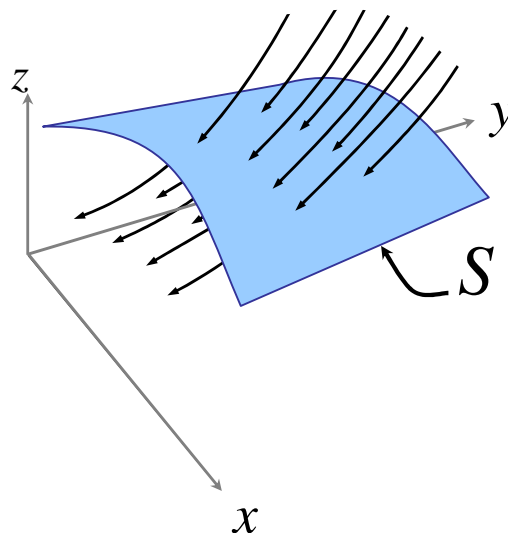

Figure C.9: The flow rate through a curved surface is calculated with a surface integral.

different regions of S associated with the projections ΔA_i . By focusing on R and equal-sized divisions of R (rather than dividing S directly), we can arrive at the appropriate integral expression.

Figure C.10 shows the area S and its projection R in the xy plane. The area R has been divided into rectangles of area ΔA_i , and we will only consider the ΔA_i that are wholly contained within the boundaries of R .

For each ΔA_i in the xy plane we choose a point within ΔA_i , and we call this point $(x_i, y_i, 0)$. The point (x_i, y_i, z_i) is located directly above $(x_i, y_i, 0)$ on the surface S . If we draw a plane tangent to S through (x_i, y_i, z_i) , we can construct an area ΔS_i that is a portion of the tangent plane whose projection onto the xy plane is ΔA_i (Figure C.10). We will soon take a limit as ΔA_i becomes infinitesimally small, and therefore it is not important which point $(x_i, y_i, 0)$ is chosen so long as it is in ΔA_i .

Each tangent-plane area ΔS_i approximates a portion of the surface S , and thus we can write the mass flow through S as a sum of the mass flows through all the regions ΔS_i . The mass flow through ΔS_i may be written as

$$\begin{aligned} \text{Mass flow rate} \\ \text{through the } i^{\text{th}} \\ \text{tangent plane } \Delta S_i \end{aligned} = \left(\frac{\text{mass}}{\text{volume}} \right) \left(\frac{\text{volume flow}}{\text{time}} \right) \quad (\text{C.43})$$

$$= \rho(x_i, y_i, z_i) (\underline{v}(x_i, y_i, z_i) \cdot \hat{n}_i) \Delta S_i \quad (\text{C.44})$$

As before, the quantity $\underline{v} \cdot \hat{n}$ is used in the expression for the volume flow per unit time above since only the component of velocity perpendicular to ΔS_i contributes to the flow crossing

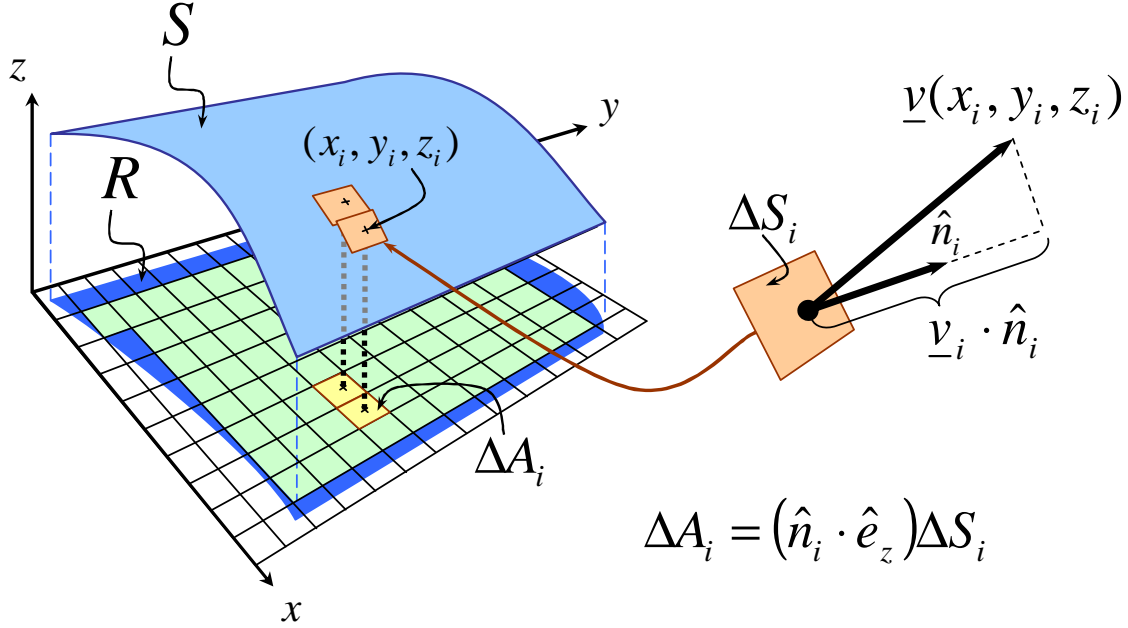

Figure C.10: For a surface that is not flat, we first project the surface onto a plane called the xy plane. We then divide up the projection and proceed to write and sum up the mass flow rate through each small piece. The surface differential ΔS can be related to ΔA , its projection onto the xy plane, by $\Delta S = \Delta A / (\hat{n} \cdot \hat{e}_z)$.

ΔS_i . For the current case of a curved surface, the direction of the unit normal \hat{n}_i will vary with position.

We now sum over all tangent-planes ΔS_i that are associated with those projections ΔA_i that are fully contained within R . Subsequently we take the limit as ΔA becomes small.

$$\text{Mass flow rate through } S \approx \sum_{i=1}^N \rho(x_i, y_i, z_i) (\underline{v}(x_i, y_i, z_i) \cdot \hat{n}_i) \Delta S_i \quad (\text{C.45})$$

$$\text{Mass flow rate through } S = \lim_{\Delta A \rightarrow 0} \left[\sum_{i=1}^N \rho(x_i, y_i, z_i) (\underline{v}(x_i, y_i, z_i) \cdot \hat{n}_i) \Delta S_i \right] \quad (\text{C.46})$$

The right-hand-side of equation C.46 is similar to equation C.36, the definition of the double integral, but it is not quite the same, since ΔS_i appears rather than ΔA_i . We can relate the tangent-plane area ΔS_i and the projected area ΔA_i through geometry (see Appendix C.4). The relationship is

$$\Delta A_i = (\hat{n}_i \cdot \hat{e}_z) \Delta S_i \quad (\text{C.47})$$

Substituting equation C.47 into equation C.46 we obtain

$$\begin{aligned} \text{Mass flow rate} \\ \text{through } S \end{aligned} = \lim_{\Delta A \rightarrow 0} \left[\sum_{i=1}^N \frac{\rho(x_i, y_i, z_i) (\underline{v}(x_i, y_i, z_i) \cdot \hat{n}_i)}{\hat{n}_i \cdot \hat{e}_z} \Delta A_i \right] \quad (\text{C.48})$$

Comparison with equation C.36 shows that this expression may be written as a double integral over the projected area R .

$$\begin{aligned} \text{Mass flow rate} \\ \text{through } S \end{aligned} = \iint_{\mathcal{R}} \frac{\rho \underline{v} \cdot \hat{n}}{\hat{n} \cdot \hat{e}_z} dA \quad (\text{C.49})$$

If we define $dS \equiv dA/(\hat{n} \cdot \hat{e}_z)$ then equation C.49 becomes

$$\boxed{\begin{aligned} \text{Mass flow rate} \\ \text{through} \\ \text{arbitrary surface } S \end{aligned} = \iint_S \rho \underline{v} \cdot \hat{n} dS} \quad (\text{C.50})$$

This final result is written as an integral over the surface S , which is how mass flow rate through an arbitrary surface is usually expressed. The previous version of this result in equation C.49 may be more convenient during actual calculations, however[185].

C.2.1.4 Surface Area

Another quantity of interest is the surface area of an arbitrary surface. Consider the surface S discussed in the last section (Figure C.10). If we project the surface onto the divided xy plane as before and construct the tangent planes ΔS_i , the surface area S may be written as the limit of a sum as follows.

$$\begin{aligned} \text{Surface area} \\ \text{of } S \end{aligned} \approx \sum_{i=1}^N \Delta S_i \quad (\text{C.51})$$

$$\begin{aligned} \text{Surface area} \\ \text{of } S \end{aligned} = \lim_{\Delta A \rightarrow 0} \left[\sum_{i=1}^N \Delta S_i \right] \quad (\text{C.52})$$

$$= \lim_{\Delta A \rightarrow 0} \left[\sum_{i=1}^N \frac{\Delta A_i}{(\hat{n}_i \cdot \hat{e}_z)} \right] \quad (\text{C.53})$$

Comparing this expression with the definition of the double integral (equation C.36) and again writing $dS \equiv dA/(\hat{n} \cdot \hat{e}_z)$, we obtain the equation for the surface area of an arbitrary surface.

$$\boxed{\begin{aligned} \text{Surface area} \\ \text{of } S \end{aligned} = \iint_{\mathcal{R}} \frac{dA}{(\hat{n} \cdot \hat{e}_z)} = \iint_S dS} \quad (\text{C.54})$$

We can illustrate the use of equation C.54 with an example.

EXAMPLE C.2 *What is the total surface area of a cylinder of radius R and length L ?*

SOLUTION This is a problem from elementary geometry, and the solution is

$$\begin{aligned} \text{Total surface} \\ \text{area of cylinder} \end{aligned} = 2\pi RL + 2\pi R^2 \quad (\text{C.55})$$

This result can be calculated in cylindrical coordinates as follows.

$$\begin{aligned} \text{Areas of} \\ \text{top/bottom} \end{aligned} = \int_S dS = \int_0^R \int_0^{2\pi} r \, dr d\theta \quad (\text{C.56})$$

$$= 2\pi \left. \frac{r^2}{2} \right|_0^R = \pi R^2 \quad (\text{C.57})$$

$$\begin{aligned} \text{Area of} \\ \text{sides} \end{aligned} = \int_S dS = \int_0^L \int_0^{2\pi} R \, d\theta dz = 2\pi RL \quad (\text{C.58})$$

$$\begin{aligned} \text{Total surface} \\ \text{area of cylinder} \end{aligned} = 2\pi RL + 2\pi R^2 \quad (\text{C.59})$$

This calculation was straightforward because we could easily write dS in the cylindrical coordinate system.

For shapes that are irregular or unusual, we must use the version of equation C.54 written in terms of an integral over dA .

$$\begin{aligned} \text{Surface area} \\ \text{of } S \end{aligned} = \iint_{\mathcal{R}} \frac{dA}{(\hat{n} \cdot \hat{e}_z)} = \iint_S dS \quad (\text{C.60})$$

We will not use the cylindrical coordinate system in this case; we will carry out our integration in the cartesian systems shown in Figure C.11.

We showed in section C.2.1.1 how to calculate the areas of the top and bottom of the cylinder in a general coordinate system. To calculate the area of the cylindrical sides, we will divide the cylinder in half lengthwise, project it onto a surface \mathcal{R} in the xy -plane, calculate the area using equation C.54, and multiply by 2 to get the total area of the sides of the cylinder.

We begin with equation C.54, which is an integration over the rectangular projection \mathcal{R} . For our chosen coordinate system, $dA = dydx$, and the limits of x and y that span \mathcal{R} are $0 \leq x \leq L$ and $-R \leq y \leq +R$.

$$\begin{aligned} \text{Surface area} \\ \text{of half cylinder} \end{aligned} = \iint_{\mathcal{R}} \frac{dA}{(\hat{n} \cdot \hat{e}_z)} \quad (\text{C.61})$$

$$= \int_0^L \int_{-R}^{+R} \frac{1}{(\hat{n} \cdot \hat{e}_z)} \, dydx \quad (\text{C.62})$$

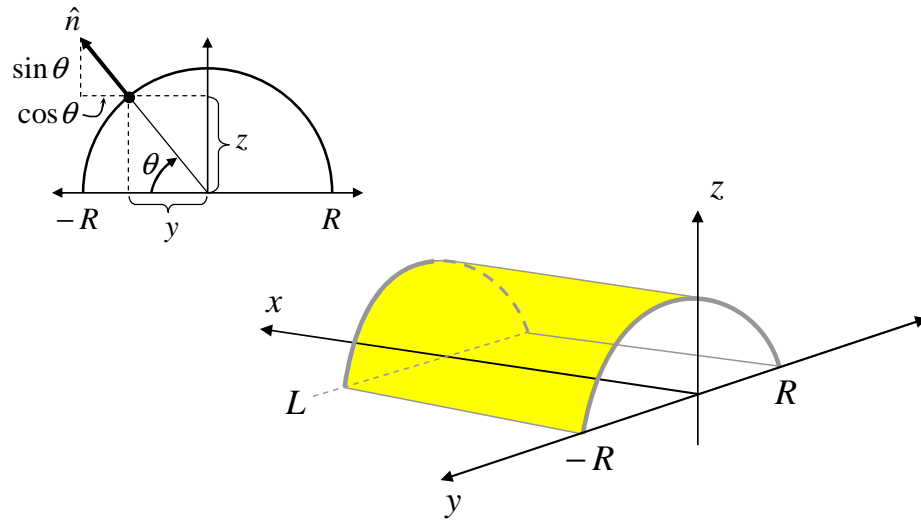

Figure C.11: The methods of this section can be used to formally calculate the surface area of any volume; one example where we can check our final results is the surface area of a right circular cylinder.

The unit normal \hat{n} to the surface is a function of position. From Figure C.11 we see that at an arbitrary point x, y, z , n can be written as

$$\hat{n} = \cos \theta \hat{e}_y + \sin \theta \hat{e}_z = \begin{pmatrix} 0 \\ \cos \theta \\ \sin \theta \end{pmatrix}_{xyz} \quad (\text{C.63})$$

$$\cos \theta = \frac{y}{R} \quad (\text{C.64})$$

$$\sin \theta = \frac{z}{R} = \frac{\sqrt{R^2 - y^2}}{R} \quad (\text{C.65})$$

Therefore $\hat{n} \cdot \hat{e}_z = \sin \theta = \sqrt{R^2 - y^2}/R$, and the rest of the solution follows.

$$\begin{aligned} \text{Surface area of half cylinder} &= \int_0^L \int_{-R}^{+R} \frac{1}{(\hat{n} \cdot \hat{e}_z)} dy dx \quad (\text{C.66}) \end{aligned}$$

$$= \int_0^L \int_{-R}^{+R} \frac{R}{\sqrt{R^2 - y^2}} dy dx \quad (\text{C.67})$$

$$= LR \int_{-R}^{+R} \frac{1}{\sqrt{R^2 - y^2}} dy \quad (\text{C.68})$$

$$= LR \sin^{-1} \frac{y}{R} \Big|_{-R}^R = LR \left[\frac{\pi}{2} - \left(-\frac{\pi}{2} \right) \right] \quad (\text{C.69})$$

$$= \pi RL \quad (\text{C.70})$$

Thus, the surface area of the sides of a half-cylinder is πRL and of the full-cylinder is $2\pi RL$. The total surface area of the cylinder is the area of the sides plus the areas of the top and bottom.

$$\begin{array}{l} \text{Total surface} \\ \text{area of cylinder} \end{array} = 2\pi RL + 2\pi R^2 \quad (\text{C.71})$$

No special coordinate system was required for this calculation; we needed to know only the equations of the boundary, which allowed us to calculate \hat{n} and $\hat{n} \cdot \hat{e}_z$.

C.2.2 Triple Integrals

Integrals in three dimensions $((x, y, z))$ are called triple integrals. Like the double integral and the single integral, the triple integral is a limit of a sum. The simplest application of the triple integral is to calculate the volume of an arbitrary solid.

C.2.2.1 Volume

Consider a solid of arbitrary shape with a volume V (Figure C.12). To calculate V we construct the three-dimensional version of a grid by drawing bounding planes parallel to the x , y , and z axes at intervals Δx , Δy , and Δz , respectively. These planes create a grid of volumes $\Delta V = \Delta x \Delta y \Delta z$ that fill all of space. Some of these volumes are wholly enclosed within V (shown in Figure C.12), some are cut by the outer surface of V , and some are outside of V (not shown). We will estimate the volume of V by summing only those volumes that are wholly within V .

$$V = \begin{array}{l} \text{Volume} \\ \text{of solid} \end{array} \approx \sum_{i=1}^N \Delta V_i \quad (\text{C.72})$$

In the limit that Δx , Δy , and Δz go to zero, the approximation in equation C.72 becomes the exact volume of the solid.

$$V = \begin{array}{l} \text{Volume} \\ \text{of solid} \end{array} = \lim_{\Delta V \rightarrow 0} \left[\sum_{i=1}^N \Delta V_i \right] \quad (\text{C.73})$$

We define the triple integral to be this limit of the sum.

$$\begin{array}{l} \text{Volume of a solid} \\ \text{or Triple Integral} \\ \text{(version 1) defined} \end{array} \quad \boxed{I = \iiint_V dV \equiv \lim_{\Delta V \rightarrow 0} \left[\sum_{i=1}^N \Delta V_i \right]} \quad (\text{C.74})$$

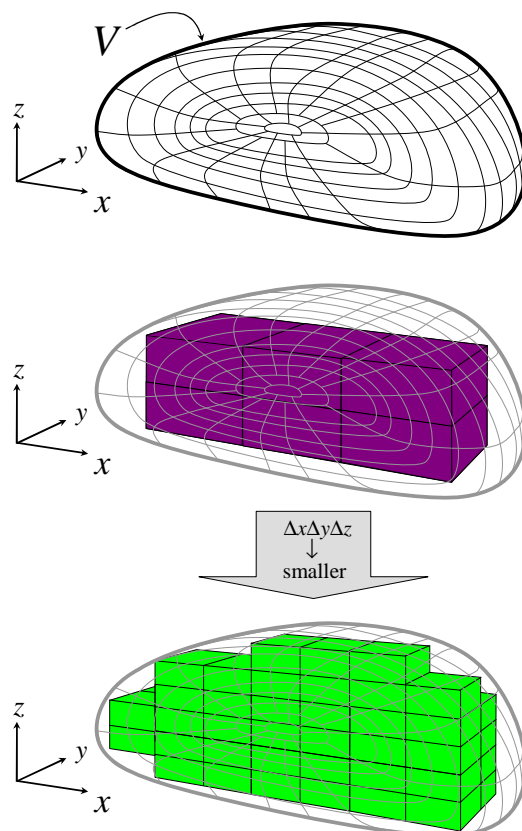

Figure C.12: To calculate the volume V of an arbitrary solid, we divide space into rectangular parallelepipeds (rectangular boxes) of volume $\Delta x \Delta y \Delta z$. In the limit that the volume $\Delta x \Delta y \Delta z$ goes to zero, the total volume of the solid is equal to the sum of the volumes of all the parallelepipeds that are located within the solid. Only the wholly enclosed ΔV_i are shown above.

C.2.2.2 Mass

Closely related to volume is the concept of mass. We can use the idea of the triple integral to calculate the mass of an arbitrary solid.

Consider once again the solid of arbitrary shape in Figure C.12. Let $\rho(x, y, z)$ be the density of the solid as a function of position. We can approximate the mass of the solid by dividing up the solid as we did when calculating its volume. The mass of the solid is approximately equal to the sum of the masses of those volumes $\Delta V_i = \Delta x_i \Delta y_i \Delta z_i$ located inside the solid.

$$\begin{array}{l} \text{Mass of a solid} \\ \text{of volume } V \end{array} \approx \sum_{i=1}^N \rho(x_i, y_i, z_i) \Delta V_i \quad (\text{C.75})$$

In the limit that Δx , Δy , and Δz go to zero, this approximation becomes the exact mass of the solid.

$$\begin{array}{l} \text{Mass of a solid} \\ \text{of volume } V \end{array} = \lim_{\Delta V \rightarrow 0} \left[\sum_{i=1}^N \rho(x_i, y_i, z_i) \Delta V_i \right] \quad (\text{C.76})$$

We define the triple integral of the function ρ to be this limit of the sum.

$$\begin{array}{l} \text{Mass of a solid or} \\ \text{Triple Integral of a} \\ \text{function defined} \end{array} \quad \boxed{I = \iiint_V \rho(x, y, z) dV \equiv \lim_{\Delta V \rightarrow 0} \left[\sum_{i=1}^N \rho(x_i, y_i, z_i) \Delta V_i \right]} \quad (\text{C.77})$$

This definition is valid for the triple integral of any function $f(x, y, z)$ with $f(x, y, z)$ substituting for $\rho(x, y, z)$ in equation C.77. The techniques used to evaluate triple integrals may be found in standard calculus texts[185].

C.3 Differential Equations

Engineers and scientists study the solutions of differential equations in depth; here we give a brief review of the most common solution techniques for the types of equations encountered in the introductory study of fluid mechanics.

In outlining mathematical techniques that are used to solve differential equations, it is helpful to be systematic. To this end we divide differential equations into those that depend on a single independent variable and those that depend on several independent variables. The first group of equations deal only with ordinary derivatives (df/dx , for example), and this group is called ordinary differential equations (ODEs). The second group concerns partial derivatives ($\partial f/\partial x, \partial f/\partial y$, for example), and these are known as partial differential equations (PDEs).

The order of an ordinary differential equation is the order of the highest derivative that appears in the equation. Thus

$$\frac{dy}{dx} + 2xy + 6 = 0 \quad (\text{C.78})$$

is a first-order ODE for the variable $y = f(x)$ because it only contains first derivatives of y . An example of a higher-order ODE is

$$\frac{d^2u}{dr^2} - r \frac{du}{dr} = 0 \quad (\text{C.79})$$

which is a second-order ODE for the variable $u = f(r)$.

A differential equation is thus characterized by the number of independent variables in the equation (one variable for ODEs, two or more variables for PDEs), and its order, that is,

how high the derivatives are in the equation. The order of the differential equation tells us how many boundary conditions are needed to fully solve the equation. Because integration introduces arbitrary constants into the solution for the function, each integration necessitates a boundary condition. Boundary conditions are values of the function at known values of the independent variables. Second-order differential equations require two boundary conditions while first-order differential equations require only one boundary condition.

Also quite significant is whether the equation is linear or nonlinear[20]. A differential equation is linear if it is a linear function of the variable and of all its derivatives. The general linear ordinary differential equation of order n is

$$a_0(x) \frac{d^n y}{dx^n} + a_1(x) \frac{d^{n-1} y}{dx^{n-1}} + \cdots + a_{n-1}(x) \frac{dy}{dx} + a_n(x) y = g(x) \quad (\text{C.80})$$

Note that in equation C.80 each term has only one derivative in it, multiplied by a function of the independent variable x . A nonlinear ODE has terms where, for example, the function and its first derivative are multiplied together.

$$\frac{d^2 v}{dx^2} + v h(x) \frac{dv}{dx} = g(x) \quad (\text{C.81})$$

The function $v = f(x)$ appears in the second term multiplied by its first derivative; this nonlinear term complicates the equation considerably.¹

The differential equations we solve to completion in this text are linear differential equations, but the equations of fluid mechanics are in general nonlinear. In the sections that follow we review some introductory techniques for solving two types of ODE and one type of PDE. For more information, see the mathematics literature[20]. Note that although modern calculators are helpful in performing many integrations, it is often up to us to reduce the problem to a solvable form before the calculator solution is helpful.

C.3.1 Separable Equations (ODEs)

Ordinary differential equations (ODEs) are functions of a single variable, for example $y = f(x)$. An ordinary, first-order differential equation (first-order ODE) may be written as

$$\frac{dy}{dx} = \phi(x, y) \quad (\text{C.82})$$

$$dy = \phi(x, y) dx \quad (\text{C.83})$$

The function $\phi(x, y)$ is a multivariable function. If equation C.83 can be written in the following form,

$$dy = \frac{h(x)}{g(y)} dx \quad (\text{C.84})$$

$$g(y) dy = h(x) dx \quad (\text{C.85})$$

¹Equation C.81 appears in fluid mechanics as part of the momentum balance for compressible fluids in one particular flow.

then the equation is called separable, since all the terms explicitly containing y are on the left of equation C.85 and all the terms containing x explicitly are on the right. With this rearrangement we have simplified the multivariable problem to two single-variable problems. We can now integrate the two sides of the equation separately.

$$\int g(y)dy = \int h(x)dx + C \quad (\text{C.86})$$

where C is an arbitrary constant of integration that depends on the boundary conditions.

EXAMPLE C.3 Solve for $y = f(x)$.

$$\frac{dy}{dx} = 6y \quad (\text{C.87})$$

SOLUTION By algebraic rearrangements we can write equation C.87 as follows.

$$\frac{dy}{y} = 6dx \quad (\text{C.88})$$

This can now be integrated directly and solved.

$$\int \frac{1}{y} dy = \int 6dx \quad (\text{C.89})$$

$$\ln(y) = 6x + C \quad (\text{C.90})$$

$$e^{\ln y} = e^{6x+C} = e^{6x}e^C \quad (\text{C.91})$$

$$\boxed{y = f(x) = \tilde{C}e^{6x}} \quad (\text{C.92})$$

where $\tilde{C} = e^C$ is an arbitrary constant of integration that must be determined by a boundary condition.

EXAMPLE C.4 Solve for $y(x)$:

$$y = \frac{dy}{dx}x - 3x^3y \quad (\text{C.93})$$

By algebraic rearrangements, we can write equation C.93 as follows.

$$\frac{dy}{y} = \left(3x^2 + \frac{1}{x}\right) dx \quad (\text{C.94})$$

Integrating both sides we obtain,

$$\ln y = x^3 + \ln x + C \quad (\text{C.95})$$

$$\ln\left(\frac{y}{x}\right) = x^3 + C \quad (\text{C.96})$$

$$\frac{y}{x} = e^{x^3+C} = e^{x^3} + e^C \quad (\text{C.97})$$

$$\boxed{y = f(x) = \tilde{C}x e^{x^3}} \quad (\text{C.98})$$

where $\tilde{C} = e^C$ is an unknown constant of integration. Substituting equation C.98 into equation C.93 confirms the result.

C.3.2 Integrating Functions (ODEs)

We can integrate ordinary differential equations $y = f(x)$ of the following type,²

$$\frac{dy}{dx} + y a(x) + b(x) = 0 \quad (\text{C.99})$$

by using an integrating function, $u(x)$, where $u(x)$ is defined as:

$$u(x) = e^{\int a(x) dx} \quad (\text{C.100})$$

To solve equation C.99, we first multiply through by $u(x)$.

$$u(x) \frac{dy}{dx} + u(x)a(x)y(x) = -b(x) u(x) \quad (\text{C.101})$$

We seem to have complicated the equation, but actually it has become simpler. The choice of $u(x)$ in equation C.100 makes it now possible to write the left-hand side of equation C.101 as the x -derivative of the combination $u(x)y$. To check this, consider the x -derivative of $u(x)y$. Using the product rule we obtain

$$\frac{d}{dx} (u(x)y(x)) = u \frac{dy}{dx} + y \frac{du}{dx} \quad (\text{C.102})$$

²This type of differential equation is classified as a linear equation of the first order[76].

We calculate du/dx from equation C.100.

$$u = e^{\int a(x)dx} \quad (\text{C.103})$$

$$\ln(u) = \int a(x)dx \quad (\text{C.104})$$

$$\frac{1}{u} \frac{du}{dx} = a(x) \quad (\text{C.105})$$

$$\frac{du}{dx} = a(x)u(x) \quad (\text{C.106})$$

Therefore

$$\frac{d}{dx} (u(x)y(x)) = u \frac{dy}{dx} + a(x)u(x)y \quad (\text{C.107})$$

which is the left-hand side of equation C.101, and the factorization checks out.

We can therefore write equation C.101 as

$$\frac{d}{dx} (u(x) y(x)) = -b(x) u(x) \quad (\text{C.108})$$

The final solution to the differential equation comes from integrating equation C.108 to obtain $(u(x)y(x))$ and then solving for $y(x)$.

$$\frac{d}{dx} (u y) = -b(x) u(x) \quad (\text{C.109})$$

$$\int d(u y) = - \int b(x) u(x) dx \quad (\text{C.110})$$

$$u y = - \int b(x') u(x') dx' + C \quad (\text{C.111})$$

$$y = f(x) = \frac{1}{u(x)} \left\{ - \int b(x') u(x') dx' + C \right\} \quad (\text{C.112})$$

where C is an arbitrary constant of integration, and x' is a dummy variable of integration. We introduce this notation to avoid any confusion between the x on the outside of the integral and the x' within the integral.

EXAMPLE C.5 Solve for $y = f(x)$:

$$\frac{dy}{dx} + 2xy = 3x \quad (\text{C.113})$$

This equation may be solved using the integrating function method. Rearranging equation C.113 we obtain,

$$\frac{dy}{dx} + 2xy - 3x = 0 \quad (\text{C.114})$$

and comparing to equation C.99 we recognize that $a(x) = 2x$ and $b(x) = -3x$. We calculate $u(x)$ from

$$\int 2x \, dx = x^2 \quad (\text{C.115})$$

$$u(x) = e^{(\int a(x) \, dx)} = e^{x^2} \quad (\text{C.116})$$

Multiplying equation C.113 by the integrating function $u(x)$ we obtain,

$$\frac{dy}{dx} e^{x^2} + 2xe^{x^2}y = 3xe^{x^2} \quad (\text{C.117})$$

By the factorization outlined in equation C.107 this becomes

$$\frac{d}{dx} (e^{x^2} y) = 3xe^{x^2} \quad (\text{C.118})$$

We can verify the factorization above by carrying out the differentiation on the left-hand side. Integrating equation C.118 we obtain,

$$e^{x^2} y = \int 3x' e^{x'^2} \, dx' + C \quad (\text{C.119})$$

where C is an unknown constant of integration. Carrying out the integration on the right side (using a calculator, if desired), we obtain the final result.

$$e^{x^2} y = \int 3x' e^{x'^2} \, dx' + C \quad (\text{C.120})$$

$$= \frac{3}{2} \int e^{x^2} (2x dx) + C \quad (\text{C.121})$$

$$= \frac{3}{2} e^{x^2} + C \quad (\text{C.122})$$

$$\boxed{y = f(x) = \frac{3}{2} + Ce^{x^{-2}}} \quad (\text{C.123})$$

Substituting equation C.123 into equation C.113 confirms the result.

C.3.3 Separable Equations (PDEs)

Partial differential equations (PDEs) are functions of a two independent variables, such as $z = f(x, y)$. In multivariable problems such as are encountered in fluid mechanics, we are called upon to solve partial differential equations (PDEs). The simplest type of partial differential equation to solve is the separable PDE.

A general first-order PDE for the variable $z = f(x, y)$ may be written as,

$$a(x, y) \frac{\partial z}{\partial x} + b(x, y) \frac{\partial z}{\partial y} = 1 \quad (\text{C.124})$$

It is a challenge to solve complex equations of this type. It may work out, however, that the solution for $z(x, y)$ may be separated into the product of two single-variable functions, for example $g(x)$ and $h(y)$.

$$z(x, y) = g(x)h(y) \quad (\text{C.125})$$

If $z(x, y)$ may be written this way, this function is termed separable. Substituting equation C.125 into the general equation for the PDE (equation C.124), we obtain,

$$\frac{\partial z}{\partial x} = \frac{\partial}{\partial x} (g(x)h(y)) = h(y) \frac{dg}{dx} \quad (\text{C.126})$$

$$\frac{\partial z}{\partial y} = \frac{\partial}{\partial y} (g(x)h(y)) = g(x) \frac{dh}{dy} \quad (\text{C.127})$$

$$a(x, y) \frac{dg}{dx} h(y) + b(x, y) \frac{dh}{dy} g(x) = 1 \quad (\text{C.128})$$

$$a(x, y) \frac{dg}{dx} \frac{1}{g(x)} + b(x, y) \frac{dh}{dy} \frac{1}{h(y)} = \frac{1}{g(y)h(x)} \quad (\text{C.129})$$

If the equations cooperate (which they are not doing so far because we have not specified $a(x, y)$ or $b(x, y)$), then the PDE separates into two expressions that are equal to each other.

$$X(x) = Y(y) \quad (\text{C.130})$$

If we are able to obtain a separated result in the form of equation C.130, the left side is a function of x only, and the right side is a function of y only. This is a very particular circumstance, because both x and y are independent variables. As independent variables, x and y may be chosen to be any values whatsoever, completely independent of one another. For the functions $X(x)$ and $Y(y)$ in equation C.130 to be equal to each other for all possible choices of x and y , the two functions must individually be equal to the same constant. We call that constant λ .

$$X(x) = Y(y) = \lambda = \text{constant} \quad (\text{C.131})$$

Through this rearrangement we obtain two separate, ordinary differential equations related to the original PDE $z = f(x, y)$ through the functions $g(x)$ and $h(y)$ ($z(x, y) = g(x)h(y)$). We can solve for $g(x)$ and $h(y)$ by solving these ODEs.

$$X(x) = Y(y) = \lambda = \text{constant} \quad (\text{C.132})$$

$$X(x) = \lambda \quad (\text{C.133})$$

$$Y(y) = \lambda \quad (\text{C.134})$$

The ODEs may be solved by the usual solution methods.

EXAMPLE C.6 Solve the following PDE for $z = f(x, y)$:

$$2x^2 \frac{\partial z(x, y)}{\partial x} - \frac{\partial z(x, y)}{\partial y} = 0 \quad (\text{C.135})$$

Solution: First we postulate that $z = f(x, y)$ may be written as $z(x, y) = g(x)h(y)$. Calculating the appropriate partial derivatives in terms of g and h and substituting these into equation C.135 we obtain,

$$\frac{\partial z}{\partial x} = \frac{dg}{dx} h \quad (\text{C.136})$$

$$\frac{\partial z}{\partial y} = \frac{dh}{dy} g \quad (\text{C.137})$$

$$2x^2 \frac{dg}{dx} h - \frac{dh}{dy} g = 0 \quad (\text{C.138})$$

We now rearrange equation C.138 to group functions of x on one side of the equation and functions of y on the other side.

$$2x^2 \frac{dg}{dx} \frac{1}{g} = \frac{dh}{dy} \frac{1}{h} \quad (\text{C.139})$$

Since the left-hand side of equation C.139 is only a function of x and the right-hand side of equation C.139 is only a function of y , each side must be equal to the same constant. Calling this constant λ , we obtain two ordinary differential equations, one for $g(x)$ and one for $h(y)$.

$$\frac{1}{g} 2x^2 \frac{dg}{dx} = \lambda \quad (\text{C.140})$$

$$\frac{dh}{dy} \frac{1}{h} = \lambda \quad (\text{C.141})$$

Solving equations C.140 and C.141 for $g(x)$ and $h(y)$, we can then reconstruct $z = f(x, y)$. This step may be performed on a calculator.

$$g(x) = C_1 e^{-\frac{\lambda}{2x}} \quad (\text{C.142})$$

$$h(y) = C_2 e^{\lambda y} \quad (\text{C.143})$$

$$z = f(x, y) = C_3 e^{\lambda(y - \frac{1}{2x})} \quad (\text{C.144})$$

where $C_3 = C_1 C_2$. Substituting equation C.144 into equation C.135 confirms that the result obtained is a solution to the original PDE.

EXAMPLE C.7 *In problem 7.55, the flow produced in a semi-infinite fluid by an oscillating wall is considered (oscillation frequency is ω). A semi-infinite fluid is a fluid that extends from a straight wall into the distance as far as the eye can see. This problem is related to a flow that takes place in a flow-testing device. In that problem the following partial differential equation appears.*

$$\rho \frac{\partial v_x}{\partial t} = \mu \frac{\partial^2 v_x}{\partial y^2} \quad (\text{C.145})$$

Solve this differential equation.

SOLUTION In equation C.145, ρ and μ are constants and $v_x = f(y, t)$ is the multivariable function we seek, and x_2 and t are the two independent variables. This PDE is separable, as we can see by postulating the following solution:

$$\text{postulated solution:} \quad v_x(y, t) = \Psi(y)\Phi(t) \quad (\text{C.146})$$

$$= \Psi(y)e^{i\omega t} \quad (\text{C.147})$$

where ω is the frequency at which the wall oscillates, $i = \sqrt{-1}$, and t is time. The choice of the exponential form for the time-dependence comes from the oscillatory nature of the problem, and it is a good guess, as we now show. Knowing to make this choice comes from experience with oscillating problems of this type[20].

We have postulated a separable solution to our partial differential equation, and to see if it is appropriate, we now substitute the postulated solution back

into the original PDE.

$$v_x(y, t) = \Psi(y)e^{i\omega t} \quad (\text{C.148})$$

$$\frac{\partial v_x}{\partial t} = \Psi(y) (i\omega) e^{i\omega t} \quad (\text{C.149})$$

$$\frac{\partial v_x}{\partial y} = \frac{d\Psi}{dy} e^{i\omega t} \quad (\text{C.150})$$

$$\frac{\partial^2 v_x}{\partial y^2} = \frac{d^2\Psi}{dy^2} e^{i\omega t} \quad (\text{C.151})$$

Substituting into equation C.145,

$$\rho \frac{\partial v_x}{\partial t} = \mu \frac{\partial^2 v_x}{\partial y^2} \quad (\text{C.152})$$

$$\rho \Psi(y) (i\omega) e^{i\omega t} = \mu \frac{d^2\Psi}{dy^2} e^{i\omega t} \quad (\text{C.153})$$

$$\rho \Psi(y) (i\omega) = \mu \frac{d^2\Psi}{dy^2} \quad (\text{C.154})$$

$$\frac{d^2\Psi}{dy^2} = \left[\frac{i\rho\omega}{\mu} \right] \Psi(y) \quad (\text{C.155})$$

The postulated solution has resulted in turning our PDE problem into a second-order ODE problem (equation C.155). The choice of the time-dependent part as an exponential was key to this simplification: because the exponential function regenerates itself when the derivative is taken, it appears both on the left and right of equation C.153 and thus drops out.

We now face the task of solving equation C.155, which is an ordinary differential equation, for $\Psi = f(y)$. Everything in square brackets is a constant; we rename the quantity in square brackets as α .

$$\frac{d^2\Psi}{dy^2} = \alpha\Psi \quad (\text{C.156})$$

This particular second-order ordinary differential equation with constant coefficients is well known, as it occurs in many systems involving oscillation. The solution to equation C.156 is given below[20].

$$\Psi(y) = C_1 e^{\sqrt{\alpha}y} + C_2 e^{-\sqrt{\alpha}y} \quad (\text{C.157})$$

where C_1 and C_2 are integration constants; there are two integration constants since equation C.156 is a second-order ODE. Combining this result with the time-dependent part (equation C.147) we obtain the final result for $v_x(y, t)$.

$$v_x(y, t) = \Psi(y)e^{i\omega t} \quad (\text{C.158})$$

$$= \left[C_1 e^{\sqrt{\alpha}y} + C_2 e^{-\sqrt{\alpha}y} \right] e^{i\omega t} \quad (\text{C.159})$$

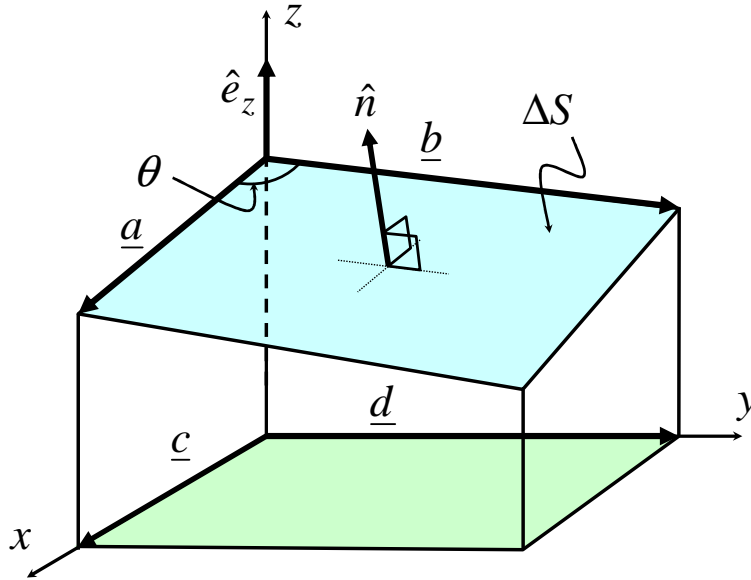

Figure C.13: Geometry for the derivation of the expression for the projection of an area onto a plane.

$$v_x(y, t) = \left[C_1 e^{(i+1)y\sqrt{\rho\omega/2\mu}} + C_2 e^{-(i+1)y\sqrt{\rho\omega/2\mu}} \right] e^{i\omega t} \quad (\text{C.160})$$

In arriving in this last result we used the fact that $\sqrt{i} = (i+1)/\sqrt{2}$. Note that to arrive at the final solution, we substituted back our combined variables (both α and $v_x = \Psi(y)\Phi(t)$), leaving our result in terms of the quantities present in the original equation (equation C.145).

C.4 Projection of a Plane

We seek to calculate the projection of an area, ΔS , in the direction, \hat{e} [185]. We will analyze this problem in a Cartesian coordinate system such that $\hat{e} = \hat{e}_z$ (Figure C.13). We choose to look at a small surface, ΔS , with unit normal, \hat{n} , where ΔS is the parallelogram enclosed by the vectors \underline{a} and \underline{b} . Note that $\underline{a} \times \underline{b}$ is parallel to \hat{n} ; we choose \underline{a} and \underline{b} such that \hat{n} and $\underline{a} \times \underline{b}$ are in the same direction.

The area $\Delta S = (a)(b) \sin \theta = |\underline{a} \times \underline{b}|$, where θ is the angle between \underline{a} and \underline{b} . The area ΔS projects down on to the x - y plane as a rectangle included by the vectors \underline{c} and \underline{d} as

shown in Figure C.13. Since \underline{a} and \underline{c} both lie in the x - z plane, we can write

$$\underline{a} = \underline{c} + \alpha \hat{e}_z \quad (\text{C.161})$$

where α is an unknown scalar. Likewise since \underline{b} and \underline{d} lie in the y - z plane we can write

$$\underline{b} = \underline{d} + \beta \hat{e}_z \quad (\text{C.162})$$

where β is also an unknown scalar. We now take the cross product of \underline{a} and \underline{b} :

$$\underline{a} \times \underline{b} = (\underline{c} + \alpha \hat{e}_z)(\underline{d} + \beta \hat{e}_z) \quad (\text{C.163})$$

$$= \underline{c} \times \underline{d} + \alpha \hat{e}_z \times \underline{d} + \underline{c} \times \beta \hat{e}_z + \alpha \hat{e}_z \times \beta \hat{e}_z \quad (\text{C.164})$$

$$= \underline{c} \times \underline{d} + \alpha(\hat{e}_z \times \underline{d}) + \beta(\underline{c} \times \hat{e}_z) \quad (\text{C.165})$$

recalling that the cross product of parallel vectors is zero ($\sin 0 = 0$). If we dot this final expression with \hat{e}_z , the last two terms on the right-hand side will drop out since they are perpendicular to \hat{e}_z . This results in

$$(\underline{a} \times \underline{b}) \cdot \hat{e}_z = (\underline{c} \times \underline{d}) \cdot \hat{e}_z \quad (\text{C.166})$$

Because the dot product is commutative, it does not matter whether the dot product with \hat{e}_z appears on the left or right above. Note that $\underline{c} \times \underline{d}$ is parallel to and in the same direction as \hat{e}_z (Figure C.13), and thus $(\underline{c} \times \underline{d}) \cdot \hat{e}_z = cd \cos 0 = cd$, which is the area of the rectangle that is the projection of ΔS onto the x - y plane.

$$\left\{ \begin{array}{l} \text{projection of} \\ \Delta S \text{ onto the} \\ \text{plane whose unit} \\ \text{normal is } \hat{e}_z \end{array} \right\} = cd = (\underline{a} \times \underline{b}) \cdot \hat{e}_z \quad (\text{C.167})$$

Finally, since n is given by

$$\hat{n} = \frac{\underline{a} \times \underline{b}}{|\underline{a} \times \underline{b}|} = \frac{\underline{a} \times \underline{b}}{\Delta S} \quad (\text{C.168})$$

Equation C.167 becomes

$$\left\{ \begin{array}{l} \text{projection of} \\ \Delta S \text{ onto the} \\ \text{plane whose unit} \\ \text{normal is } \hat{e}_z \end{array} \right\} = \hat{n} \cdot \hat{e}_z \Delta S \quad (\text{C.169})$$

C.5 Leibnitz Formula

The Leibnitz formula describes the effect of differentiating an integral. For an integral over fixed limits α and β

$$\mathcal{J}(x, t) = \int_{\alpha}^{\beta} f(x, t) dx \quad (\text{C.170})$$

the time derivative of \mathcal{J} is given by

$$\frac{d\mathcal{J}}{dt} = \frac{d}{dt} \left[\int_{\alpha}^{\beta} f(x, t) dx \right] \quad (\text{C.171})$$

$$= \int_{\alpha}^{\beta} \frac{\partial f(x, t)}{\partial t} dx \quad (\text{C.172})$$

If the limits of the integral are functions of t , $\alpha(t)$, $\beta(t)$, then

$$\mathcal{J}(x, t) = \int_{\alpha(t)}^{\beta(t)} f(x, t) dx \quad (\text{C.173})$$

the time derivative of \mathcal{J} is given by

$$\frac{d\mathcal{J}(x, t)}{dt} = \int_{\alpha(t)}^{\beta(t)} \frac{\partial f(x, t)}{\partial t} dx + f(\beta, t) \frac{d\beta}{dt} - f(\alpha, t) \frac{d\alpha}{dt} \quad (\text{C.174})$$

This is known as Leibnitz formula for single integrals. For multidimensional functions an analogous formula exists:

$$\frac{d\mathcal{J}(x, y, z, t)}{dt} = \iiint_{CV(t)} \frac{\partial f}{\partial t} dV + \iint_{S(t)} f (\underline{v} \cdot \hat{n})|_{surface} dS \quad (\text{C.175})$$

where \hat{n} is the outwardly pointing unit normal of dS and $\underline{v} \cdot \hat{n}$ is evaluated at the surface dS .

Appendix D

Special Topics

D.1 Microscopic Energy Balance

A fundamental law of nature is that energy is conserved. The first law of thermodynamics relates the time rate-of-change of energy of a body to the heat flow into the system and the work done by the system[176].

$$\begin{array}{l} \text{First law of thermodynamics:} \\ \text{Energy of a body is conserved} \end{array} \quad \frac{dE_B}{dt} = Q_{in,B} - W_{by,B} \quad (\text{D.1})$$

The term $Q_{in,B}$ is the total rate of heat flow into the body, $W_{by,B}$ is the total rate of work done by the body, and E_B is the total energy of the body, comprised of internal, kinetic, and potential energy[186, 176] (Figure 6.3):

$$E_B = U + E_k + E_p \quad (\text{D.2})$$

We discuss the meaning of these terms and how to quantify them in Chapter 6.

To write equation D.1 on fluid systems, we need to adapt this expression from being the energy balance on a body to being an energy balance on a control volume. We carry out this derivation in this section of the web appendix. At the end of the discussion below, we arrive at equation 6.78 in the text, which is equation D.31 below.

We seek to write the energy balance on a control volume rather than on a body. As with the mass and momentum balances on a control volume (equations 6.28 and 6.29), changing from the balance on a body to the balance on a control volume results in the addition of a convective term. The analysis of Chapter 3 (Figure 3.22) that resulted in the Reynolds transport theorem can be carried out for energy balances too. The correct convective energy term that emerges is analogous to the convective term for mass, with energy per unit volume

$\rho\hat{E}$ replacing density ρ (mass per unit volume).

Energy balance on a CV
(First law of thermodynamics;
Reynolds transport theorem
for energy)

$$\boxed{\frac{dE_{CV}}{dt} = Q_{in,CV} - W_{by,CV} + \iint_{CS} -(\hat{n} \cdot \underline{v})\rho\hat{E} dS} \quad (D.3)$$

In this equation E_{CV} is the total energy of the control volume, \hat{E} is the energy per unit mass of the fluid, $\hat{E} = \hat{U} + \hat{E}_k + \hat{E}_p$, and the terms $Q_{in,CV}$ and $W_{by,CV}$ are the rate of heat addition to the control volume and the rate of work done by the control volume, respectively. The convective term (the integral) represents the net flow of energy into the control volume per unit time. Equation D.3 has the same form as the mass balance on a control volume (equation 6.28) and the momentum balance on a control volume (equation 6.29). The three balance equations written for a body and for a control volume are compared in Figure 6.4.

In fluid mechanics, the energy balance in equation D.3 applied to macroscopic control volumes leads to important relationships between pressure, fluid velocity, and work by engineering devices such as pumps and turbines (see discussions of the mechanical energy balance and the Bernoulli equation in Chapter 9). Equation D.3 applied to a microscopic control volume gives the microscopic energy balance, which is a fundamental relationship used to calculate properties in non-isothermal flows. In this text we concentrate on isothermal flows, and thus the microscopic energy balance is not of central importance to us. We derive the microscopic energy balance here for completeness and as background to the macroscopic energy balance discussion in Chapter 9. For more on non-isothermal flows see the literature[18].

To apply the energy balance given in equation D.3 to the arbitrary, microscopic control volume in Figure 6.1, we work term by term to write the indicated quantities as volume and surface integrals, and we subsequently perform mathematical manipulations similar to those used in deriving the microscopic mass and momentum equations. Beginning at the left of equation D.3, the rate-of-change-of-energy term written for the arbitrary control volume becomes an integral over the arbitrary control volume CV .

$$E_{CV} = \iiint_{CV} \rho\hat{E} dV \quad (D.4)$$

$$\frac{dE_{CV}}{dt} = \frac{d}{dt} \iiint_{CV} \rho\hat{E} dV \quad (D.5)$$

$$= \iiint_{CV} \frac{\partial}{\partial t} (\rho\hat{E}) dV \quad (D.6)$$

We have used Leibniz rule for a constant volume to bring the time derivative inside the integral.

The heat flow into a control volume $Q_{in,CV}$ is due to conduction and source terms. Source terms are, for example, the heat generated by reaction or the heat generated by electrical dissipation in a wire.

$$Q_{in,CV} = Q_{in,conduction} + Q_{in,sources} \quad (D.7)$$

Conduction appears as a flux of energy through a surface. First we define the vector energy flux as $\underline{\tilde{q}}$.

$$\begin{array}{l} \text{Energy flux} \\ \text{due to conduction} \\ \text{in } \hat{q} \text{ direction} \end{array} \quad \underline{\tilde{q}} = \left(\frac{\text{energy}}{\text{area} \cdot \text{time}} \right) \hat{q} \quad (\text{D.8})$$

where \hat{q} is the direction of the energy flux. To write net conduction into the arbitrary control volume of Figure 6.1, we consider small pieces of the tangent plane ΔS_i with outwardly pointing unit normal \hat{n} . Only the portion of $\underline{\tilde{q}}$ that is normal to ΔS_i brings conducted energy across the surface. Thus,

$$\begin{array}{l} \text{Energy flux through } \Delta S_i \\ \text{due to conduction} \\ (\hat{n} \text{ normal to } \Delta S_i) \end{array} = [\hat{n} \cdot \hat{q}] \Delta S_i \quad (\text{D.9})$$

We can write the total conductive energy into CV as a sum over the fluxes through these small pieces of the tangent plane ΔS_i .

$$\begin{array}{l} \text{Heat flow into } CV \\ \text{due to conduction} \end{array} \quad Q_{in,conduction} \approx - \sum_{\substack{\text{control} \\ \text{surfaces} \\ \Delta S_i}} \Delta S_i [\hat{n} \cdot \underline{\tilde{q}}]_i \quad (\text{D.10})$$

The negative sign changes the outflow (due to the sign convention on \hat{n}) to inflow. Following the derivations early in Chapter 6 on similar quantities, we observe that equation D.10 is in the form of equation 6.8; thus

$$Q_{in,conduction} = - \lim_{\Delta A \rightarrow 0} \left[\sum_{i=1}^N \Delta S_i [\hat{n} \cdot \underline{\tilde{q}}]_i \right] \quad (\text{D.11})$$

$$= - \iint_{CS} (\hat{n} \cdot \underline{\tilde{q}}) dS \quad (\text{D.12})$$

$$= - \iiint_{CV} \nabla \cdot \underline{\tilde{q}} dV \quad (\text{D.13})$$

where we have used the divergence theorem to arrive at the volume integral from the surface integral.

The heat flow into a control volume due electrical sources is a straightforward term that may be written as an integral over the control volume.

$$\begin{array}{l} \text{Heat flow in} \\ \text{due to chemical} \\ \text{or electrical sources} \end{array} \quad Q_{in,sources} = \iiint_{CV} \left(\frac{\text{source energy}}{\text{time} \cdot \text{volume}} \right) dV \quad (\text{D.14})$$

$$Q_{in,sources} = \iiint_{CV} \mathcal{S}_e dV \quad (\text{D.15})$$

where \mathcal{S}_e is the energy produced per time per volume by the sources.

The rate-of-work done by the fluid in the control volume $W_{by,CV}$ may be calculated from the definition of work, the inner (dot) product of force and displacement; rate-of-work is force dotted with velocity[186].

$$\text{Work defined} \quad (\text{force}) \cdot (\text{displacement}) = \underline{f} \cdot \underline{x} \quad (\text{D.16})$$

$$\text{Rate-of-work defined} \quad W \equiv \underline{f} \cdot \underline{v} \quad (\text{D.17})$$

The forces on the control volume were identified during the momentum-balance discussion: the surface contact forces due to molecular interactions and the body forces. Body force (gravity) has already been accounted for in equation D.3 in the $d(m\hat{E})_{CV}/dt$ term by virtue of including the potential energy there. This leaves just the work done the molecular forces to be included in $W_{by,CV}$. We showed in Chapter 4 that the molecular force $\underline{\mathcal{F}}$ on a surface \mathcal{S} may be written as

$$\underline{\mathcal{F}} = \iint_{\mathcal{S}} \left[\hat{n} \cdot \underline{\tilde{\Pi}} \right]_{\text{at surface}} dS \quad (\text{D.18})$$

The rate-of-work done by these forces is therefore

$$\left(\begin{array}{c} \text{rate of work} \\ \text{on CV due to} \\ \text{molecular forces} \end{array} \right) W_{by,molecular\ forces} = - \iint_{CS} (\hat{n} \cdot \underline{\tilde{\Pi}}) \cdot \underline{v} dS \quad (\text{D.19})$$

Note that since $\underline{\mathcal{F}}$ is the molecular force *on* the control volume, we must introduce a negative sign to indicate work *by* the fluid in the control volume. As usual, we can break the total molecular stress $\underline{\tilde{\Pi}}$ up into two parts, $-p\underline{I}$ and $\underline{\tilde{\tau}}$. With the assistance of Table B.1 we obtain

$$W_{by,molecular\ forces} = - \iint_{CS} (\hat{n} \cdot (-p\underline{I} + \underline{\tilde{\tau}})) \cdot \underline{v} dS \quad (\text{D.20})$$

$$= \iint_{CS} p\hat{n} \cdot \underline{v} dS - \iint_{CS} \hat{n} \cdot (\underline{\tilde{\tau}} \cdot \underline{v}) dS \quad (\text{D.21})$$

$$= \iiint_{CV} \nabla \cdot (p\underline{v}) dV - \iiint_{CV} \nabla \cdot (\underline{\tilde{\tau}} \cdot \underline{v}) dV \quad (\text{D.22})$$

Again we have used the divergence theorem to arrive at the final expression above.

We now assemble the individual terms we have derived into the energy balance on a microscopic control volume, equation D.3; our development parallels the derivation of the

microscopic mass and momentum balances.

$$\text{Energy balance on CV} \quad \frac{dE_{CV}}{dt} = Q_{in,CV} - W_{by,CV} + \iint_{CS} -(\hat{n} \cdot \underline{v})\rho\hat{E} dS \quad (\text{D.23})$$

$$\begin{aligned} \frac{dE_{CV}}{dt} &= Q_{in,conduction} + Q_{in,sources} \\ &\quad - W_{by,molecular\ forces} \\ &\quad + \iint_{CS} -(\hat{n} \cdot \underline{v})\rho\hat{E} dS \end{aligned} \quad (\text{D.24})$$

$$\begin{aligned} \iiint_{CV} \frac{\partial \rho\hat{E}}{\partial t} dV &= - \iiint_{CV} \nabla \cdot \tilde{\underline{q}} dV + \iiint_{CV} \mathcal{S}_e dV \\ &\quad - \iiint_{CV} \nabla \cdot (p\underline{v}) dV + \iiint_{CV} \nabla \cdot (\tilde{\underline{\tau}} \cdot \underline{v}) dV \\ &\quad - \iiint_{CV} \nabla \cdot (\underline{v}\rho\hat{E}) dV \end{aligned} \quad (\text{D.25})$$

We have applied the divergence theorem to the convective term. Combining the terms of equation D.25 under one integral we obtain,

$$\iiint_{CV} \left[\frac{\partial (\rho\hat{E})}{\partial t} + \nabla \cdot \tilde{\underline{q}} - \mathcal{S}_e + \nabla \cdot (p\underline{v}) - \nabla \cdot (\tilde{\underline{\tau}} \cdot \underline{v}) + \nabla \cdot (\underline{v}\rho\hat{E}) \right] dV = 0 \quad (\text{D.26})$$

Because the control volume, which serves as the limits of the integration, is arbitrary, the integrand must be everywhere zero, resulting in a microscopic energy balance.

$$\frac{\partial (\rho\hat{E})}{\partial t} + \nabla \cdot \tilde{\underline{q}} - \mathcal{S}_e + \nabla \cdot (p\underline{v}) - \nabla \cdot (\tilde{\underline{\tau}} \cdot \underline{v}) + \nabla \cdot (\underline{v}\rho\hat{E}) = 0 \quad (\text{D.27})$$

$$\text{Microscopic energy balance} \quad \frac{\partial (\rho\hat{E})}{\partial t} + \nabla \cdot (\underline{v}\rho\hat{E}) = -\nabla \cdot \tilde{\underline{q}} - \nabla \cdot (p\underline{v}) + \nabla \cdot (\tilde{\underline{\tau}} \cdot \underline{v}) + \mathcal{S}_e \quad (\text{D.28})$$

Equation D.28 is the microscopic energy balance, but a more useful form maybe derived by working a bit on several terms. The left-hand side of equation D.28 may be simplified if both the time and spatial derivative expressions are expanded using the product rule of differentiation. Using Einstein notation we can show that the left-hand side of equation D.28 is equivalent to (see Table B.1 and problem 6.14)

$$\frac{\partial (\rho\hat{E})}{\partial t} + \nabla \cdot (\underline{v}\rho\hat{E}) = \rho \frac{\partial \hat{E}}{\partial t} + \hat{E} \left[\frac{\partial \rho}{\partial t} + \nabla \cdot (\rho\underline{v}) \right] + \rho (\underline{v} \cdot \nabla \hat{E}) \quad (\text{D.29})$$

$$= \rho \left(\frac{\partial \hat{E}}{\partial t} + \underline{v} \cdot \nabla \hat{E} \right) \quad (\text{D.30})$$

D.2 Further Development of the Microscopic Energy Equation

In section D.1 we derived the microscopic energy balance (equation D.31):

$$\text{Microscopic energy balance} \quad \boxed{\rho \left(\frac{\partial \hat{E}}{\partial t} + \underline{v} \cdot \nabla \hat{E} \right) = -\nabla \cdot \underline{\tilde{q}} - \nabla \cdot (p\underline{v}) + \nabla \cdot \underline{\tilde{\tau}} \cdot \underline{v} + \mathcal{S}_e} \quad (\text{D.32})$$

$$\begin{aligned} \left(\begin{array}{c} \text{rate of} \\ \text{change of} \\ \text{energy} \end{array} \right) + \left(\begin{array}{c} \text{net} \\ \text{convection} \\ \text{in} \end{array} \right) &= \left(\begin{array}{c} \text{net} \\ \text{conduction} \\ \text{in} \end{array} \right) + \left(\begin{array}{c} \text{pressure/} \\ \text{volume} \\ \text{work by} \end{array} \right) \\ &+ \left(\begin{array}{c} \text{viscous} \\ \text{work} \\ \text{by} \end{array} \right) + \left(\begin{array}{c} \text{current/} \\ \text{reaction} \\ \text{heat in} \end{array} \right) \end{aligned}$$

The left-hand side gives the time rate-of-change and the convective rate-of-change of the specific energy $\hat{E} = \hat{E}_k + \hat{E}_p + \hat{U}$. These terms together are the substantial derivative of \hat{E} (section 1.3.3). On the right-hand side of equation D.32 there are terms to account for heat flow in due to conduction, work done by the fluid due to pressure and viscous forces, and heat flow in due to sources such as reaction or electrical current.

We can also write individual expressions for the rate of change of internal, kinetic, and potential energy, and we do this in this section. As we see below, writing the expressions for the individual types of energy shows us that there are some extra terms that appear in these individual expressions. When the different energy terms are summed together, the total energy balance equation D.32 is recovered. Writing the individual rate of change of energy expressions helps us to understand the energy exchanges that occur in a fluid among the three types of energy.

D.2.1 Kinetic Energy

Kinetic energy is the energy associated with the fluid's velocity. To find the kinetic energy, we begin then with the momentum balance; we choose the form that includes the stress tensor (the Cauchy momentum equation).

$$\begin{array}{l} \text{Cauchy momentum equation} \\ \text{(microscopic momentum balance)} \end{array} \quad \rho \frac{\partial \underline{v}}{\partial t} + \rho \underline{v} \cdot \nabla \underline{v} = -\nabla p + \nabla \cdot \underline{\tilde{\tau}} + \rho \underline{g} \quad (\text{D.33})$$

Energy is the capacity to do work, and work is force times displacement[186]. To convert the force terms of the microscopic momentum balance into work terms, we need to dot the Cauchy momentum equation with the velocity \underline{v} [18].

$$\text{Rate of work defined:} \quad W = \underline{f} \cdot \underline{v} \quad (\text{D.34})$$

$$\underline{v} \cdot \left(\rho \frac{\partial \underline{v}}{\partial t} + \rho \underline{v} \cdot \nabla \underline{v} = -\nabla p + \nabla \cdot \underline{\tilde{\tau}} + \rho \underline{g} \right) \quad (\text{D.35})$$

$$\rho \underline{v} \cdot \frac{\partial \underline{v}}{\partial t} + \rho \underline{v} \cdot (\underline{v} \cdot \nabla \underline{v}) = -\underline{v} \cdot \nabla p + \underline{v} \cdot (\nabla \cdot \underline{\tilde{\tau}}) + \rho \underline{v} \cdot \underline{g} \quad (\text{D.36})$$

We can identify the left-hand side of the result in equation D.36 as the total rate of change of the kinetic energy, both the time derivative and the convective term; the derivation follows. The quantity $\frac{1}{2}m_B v^2$ is the kinetic energy associated with a body of mass m_B moving with a speed v . For fluid of density ρ moving with velocity \underline{v} the kinetic energy per unit mass is given by

$$\begin{array}{l} \text{Kinetic energy} \\ \text{per unit mass} \end{array} \quad \hat{E}_k = \frac{1}{2}v^2 = \frac{1}{2}\underline{v} \cdot \underline{v} = \frac{1}{2}\underline{v}^2 \quad (\text{D.37})$$

where $\underline{v}^2 = \underline{v} \cdot \underline{v}$. Through vector manipulations, the left-hand side of equation D.36 becomes

$$\rho \frac{\partial \left(\frac{1}{2}\underline{v}^2 \right)}{\partial t} + \rho \underline{v} \cdot \left(\frac{1}{2}\underline{v}^2 \right) = -\underline{v} \cdot \nabla p + \underline{v} \cdot (\nabla \cdot \underline{\tilde{\tau}}) + \rho \underline{v} \cdot \underline{g} \quad (\text{D.38})$$

$$\rho \left(\frac{\partial \hat{E}_k}{\partial t} + \underline{v} \cdot \nabla \hat{E}_k \right) = -\underline{v} \cdot \nabla p + \underline{v} \cdot (\nabla \cdot \underline{\tilde{\tau}}) + \rho \underline{v} \cdot \underline{g} \quad (\text{D.39})$$

where $\hat{E}_k = \underline{v}^2/2$. The right-hand side of equation D.39 may be expanded by using the following two identities from Table B.1, which result from applying the product rule of differentiation to the appropriate quantities.

$$\nabla \cdot (p\underline{v}) = p(\nabla \cdot \underline{v}) + \underline{v} \cdot \nabla p \quad (\text{D.40})$$

$$\nabla \cdot (\underline{\tilde{\tau}} \cdot \underline{v}) = \underline{\tilde{\tau}}^T : \nabla \underline{v} + \underline{v} \cdot (\nabla \cdot \underline{\tilde{\tau}}) \quad (\text{D.41})$$

Solving for the terms that appear in equation D.39 and substituting these into the that equation we obtain

$$\begin{array}{l} \text{Kinetic} \\ \text{energy} \\ \text{equation} \end{array} \quad \rho \left(\frac{\partial \hat{E}_k}{\partial t} + \underline{v} \cdot \nabla \hat{E}_k \right) = -\nabla \cdot (p\underline{v}) + p(\nabla \cdot \underline{v}) \\ + \nabla \cdot (\underline{\tilde{\tau}} \cdot \underline{v}) - \underline{\tilde{\tau}}^T : \nabla \underline{v} \\ + \rho \underline{v} \cdot \underline{g} \quad (\text{D.42})$$

Equation D.42 is an equation for the kinetic energy changes in the fluid. The left-hand side is the substantial derivative of \hat{E}_k . The right-hand side terms describe changes in kinetic energy due to two types of pressure effects, two types of viscous effects, and due to kinetic energy storage into gravitational potential energy. We can distinguish between the two types of pressure and viscous effects later in our discussion, once we have arrived at the equation for internal energy.

D.2.2 Potential Energy

We can isolate the potential energy effects by considering the term $\rho \underline{v} \cdot \underline{g}$, which appears in the kinetic energy equation (equation D.42). This term represents the kinetic energy to be gained or lost as fluid moves in a gravity potential field; in this context the acceleration due to gravity is a force per unit mass.

$$\underline{f}_{gravity} = m_B \underline{g} \quad (D.43)$$

$$\frac{\text{force}}{\text{mass}} = \underline{g} \quad (D.44)$$

and thus rate-of-work $\underline{f} \cdot \underline{v}$ of gravity per unit volume is $\rho(\underline{g} \cdot \underline{v})$. For a conservative force such as gravity[186], we can relate the force per unit mass \underline{g} to the gradient of an associated potential energy \hat{E}_p :

$$\begin{array}{l} \text{Potential energy} \\ \text{due to gravity} \end{array} \quad \underline{g} = -\nabla \hat{E}_p \quad (D.45)$$

If we now dot multiply \underline{v} on both sides of equation D.45 and multiply by ρ we obtain

$$\rho \underline{v} \cdot \nabla \hat{E}_p = -\rho \underline{v} \cdot \underline{g} \quad (D.46)$$

Since the potential energy field (the gravity field) does not change with time, $\partial \hat{E}_p / \partial t = 0$. It does no harm, therefore, to incorporate the time-derivative of potential energy into our equations. Multiplying $\partial \hat{E}_p / \partial t = 0$ by ρ and adding it to both sides of equation D.46 we obtain

$$\text{Potential energy equation} \quad \rho \left(\frac{\partial \hat{E}_p}{\partial t} + \underline{v} \cdot \nabla \hat{E}_p \right) = -\rho \underline{v} \cdot \underline{g} \quad (D.47)$$

which is an equation for the substantial derivative of potential energy. Equation D.47 is analogous to the kinetic energy equation, equation D.42.

D.2.3 Internal Energy

Internal energy is the energy that is stored in the temperature of the material or in the material's chemical arrangement, such as whether the material is a solid, a liquid, or a gas or what chemical structure the material has. We can obtain the expression for the rate-of-change of the internal energy of a fluid by subtracting the previously determined expressions for kinetic and potential energy.

Before proceeding to this subtraction, we first work a bit on the conductive-flux term of the total energy balance, equation D.32. The first term on the right-hand side of equation D.32 is the heat flow in due to conduction. The conductive flux term may be written

in terms of temperature by using Fourier's law of heat conduction[17],

$$\text{Fourier's law of heat conduction} \quad \boxed{\underline{\tilde{q}} = -k\nabla T} \quad (\text{D.48})$$

where k is the thermal conductivity. Fourier's law is one of the fundamental transport laws of nature[18] and tells us the direction of the heat flux – heat moves down a temperature gradient. Fourier's law for one-dimensional heat conduction is analogous to Newton's law of viscosity for unidirectional flow.

$$\begin{array}{l} \text{Newton's law of viscosity}^1 \\ \text{(unidirectional flow in 3-direction)} \end{array} \quad -\tilde{\tau}_{13} = \tau_{13} = -\mu \frac{\partial v_3}{\partial x_1} \quad (\text{D.49})$$

$$\text{Fourier's law of conduction} \quad \tilde{q}_1 = -k \frac{\partial T}{\partial x_1} \quad (\text{D.50})$$

The analogy between Newton's and Fourier's laws results from a shared physics: heat conduction and Newtonian momentum flux are byproducts of Brownian motion. Brownian motion is the microscopic thermal motion of molecules. This motion, when combined with a gradient – of temperature for energy conduction, or of velocity for momentum transfer – causes flux of energy or momentum. Diffusion of a chemical species down a concentration gradient is also caused by Brownian motion, and mass transport is the third of the transport processes. For more on transport phenomena, see the literature[18].

Returning to the conductive term of the energy balance, we can incorporate Fourier's law to write $\nabla \cdot \underline{\tilde{q}}$ in terms of temperature. With the definition $\nabla \cdot \nabla T = \nabla^2 T$, the conduction term of the microscopic energy balance becomes

$$\begin{aligned} -\nabla \cdot \underline{\tilde{q}} &= -\nabla \cdot (-k\nabla T) \\ &= k\nabla^2 T \end{aligned} \quad (\text{D.51})$$

The thermal conductivity k is constant.

The final rate-of-change of energy expression we seek is for the internal energy. With equations D.42 and D.47 we have expressions for the substantial derivative of kinetic and potential energies; we can subtract these equations from the overall energy equation (equation D.32) to isolate an equation for the internal energy \hat{U} .

$$\begin{array}{l} \text{Thermal} \\ \text{energy} \\ \text{equation} \end{array} \quad \rho \left(\frac{\partial \hat{U}}{\partial t} + \underline{v} \cdot \nabla \hat{U} \right) = k\nabla^2 T - p(\nabla \cdot \underline{v}) + \underline{\tilde{\tau}}^T : \nabla \underline{v} + \mathcal{S}_e \quad (\text{D.52})$$

The thermal energy equation indicates that the changes in internal energy are due to: conduction; one type of pressure effect; one type of viscous effect; and heat flow into a point due to sources (current or chemical reaction).

The appearance of $p(\nabla \cdot \underline{v})$ and $\underline{\underline{\tilde{\tau}}}^T : \nabla \underline{v}$ in both the kinetic and internal energy equations but with opposite signs helps us to identify the meaning of these terms. These two terms represent pathways by which kinetic energy is transformed into internal energy. The term $p(\nabla \cdot \underline{v})$, which may be positive or negative, represents energy exchange between kinetic and internal energy by virtue of volume change. The term $\underline{\underline{\tilde{\tau}}}^T : \nabla \underline{v}$, which is always positive (this is not shown here, but may be easily shown using Einstein notation, problem 6.15) and is therefore irreversible, represents kinetic energy conversion to internal energy by viscous dissipation.

The other instance of one type of energy converting to another is the conversion of kinetic energy into potential energy: the term $\rho \underline{v} \cdot \underline{g}$ appears in the kinetic energy equation and with the opposite sign in the potential energy equation. When a portion of fluid moves upward against gravity, its energy converts from kinetic to potential; if the fluid moves downward pulled by gravity, its energy reverses and goes from potential to kinetic. This term does not appear in the total energy equation because no overall change of energy occurs; rather, energy switches between two types of energy through this contribution.

The microscopic energy balance and the equations for the three contributing energies, internal, kinetic, and potential, are summarized in Figure D.1. In the next section we develop

<u>Energy Equations</u>	
kinetic	$\rho \left(\frac{\partial \hat{E}_k}{\partial t} + \underline{v} \cdot \nabla \hat{E}_k \right) = -\nabla \cdot (p\underline{v}) + p(\nabla \cdot \underline{v}) + \nabla \cdot (\underline{\underline{\tilde{\tau}}} \cdot \underline{v}) - \underline{\underline{\tilde{\tau}}}^T : \nabla \underline{v} + \rho \underline{v} \cdot \underline{g}$
potential	$\rho \left(\frac{\partial \hat{E}_p}{\partial t} + \underline{v} \cdot \nabla \hat{E}_p \right) = -\rho \underline{v} \cdot \underline{g}$
internal	$\rho \left(\frac{\partial \hat{U}}{\partial t} + \underline{v} \cdot \nabla \hat{U} \right) = k\nabla^2 T - p(\nabla \cdot \underline{v}) + \underline{\underline{\tilde{\tau}}}^T : \nabla \underline{v} + S_e$
total	$\rho \left(\frac{\partial \hat{E}}{\partial t} + \underline{v} \cdot \nabla \hat{E} \right) = k\nabla^2 T - \nabla \cdot (p\underline{v}) + \nabla \cdot (\underline{\underline{\tilde{\tau}}} \cdot \underline{v}) + S_e$

Figure D.1: The balance of energy on a control volume is governed by the first law of thermodynamics. Individual equations for internal, kinetic, and potential energy are derived in this section.

one additional energy equation, that for internal energy under some conditions that are quite

common for incompressible fluids.

D.2.4 Thermal Energy Equation

One final version of the microscopic energy balance is worth mentioning. For certain circumstances, we can arrive at a version of the microscopic energy balance that is explicit in temperature. A common circumstance is to consider an incompressible fluid ($\nabla \cdot \underline{v} = 0$) under constant pressure. For this circumstance we can write the internal energy in terms of the temperature and the heat capacity at constant pressure, $\hat{U} = \hat{C}_p T$ [176]. With these assumptions, the left-hand-side of equation D.52 becomes

$$\rho \left(\frac{\partial \hat{U}}{\partial t} + \underline{v} \cdot \nabla \hat{U} \right) = \rho \hat{C}_p \left(\frac{\partial T}{\partial t} + \nabla \cdot T \right) \quad (\text{D.53})$$

If we further neglect viscous dissipation ($\underline{\hat{\tau}}^T : \nabla v \approx 0$), equation D.52 becomes

Thermal energy equation (no viscous dissipation, fluid at constant p or $\rho \neq \rho(T)$)	$\rho \hat{C}_p \left(\frac{\partial T}{\partial t} + \underline{v} \cdot \nabla T \right) = k \nabla^2 T + \mathcal{S}_e \quad (\text{D.54})$
-------------------------------------------------------------------------------------------------------	-------------------------------------------------------------------------------------------------------------------------------------------------

The thermal energy equation is a single equation, which may be written in any coordinate system, as shown below for Cartesian coordinates for the version in equation D.54. The thermal energy equation written in cylindrical and spherical coordinates is listed in Table B.12.

$$\text{Cartesian} \quad \frac{\partial T}{\partial t} + \left(v_x \frac{\partial T}{\partial x} + v_y \frac{\partial T}{\partial y} + v_z \frac{\partial T}{\partial z} \right) = \frac{k}{\rho \hat{C}_p} \left[\frac{\partial^2 T}{\partial x^2} + \frac{\partial^2 T}{\partial y^2} + \frac{\partial^2 T}{\partial z^2} \right] + \frac{S}{\rho \hat{C}_p} \quad (\text{D.55})$$

The meaning of each term in the energy equations are summarized in Table D.1.

D.3 Momentum Transport in Moving Control Volumes

In Chapter 3 we were able to derive a version of Newton's second law that applied to fixed, stationary control volumes (Figure D.2). The result was the Reynolds transport theorem as applied to momentum transport.

Reynolds Transport Theorem	$\sum_{\text{on CV}} \underline{f} = \frac{d\mathcal{P}}{dt} + \iint_S (\hat{n} \cdot \underline{v}) \rho \underline{v} dS \quad (\text{D.56})$
----------------------------------	-------------------------------------------------------------------------------------------------------------------------------------------------

Table D.1: Summary of the physical meaning of terms of the microscopic total, internal, kinetic, and potential energy equations.

Term	Energy balance	Meaning
$-\nabla \cdot (p\underline{v})$	kinetic, total	total pressure work on fluid
$p(\nabla \cdot \underline{v})$	kinetic	decrease in kinetic energy due to compression (reversible)
$-p(\nabla \cdot \underline{v})$	internal	increase in internal energy due to compression (reversible)
$\nabla \cdot (\underline{\tilde{\tau}} \cdot \underline{v})$	kinetic, total	total work on fluid due to viscous forces
$\underline{\tilde{\tau}}^T : \nabla \underline{v}$	internal	increase in internal energy due to viscous heating (irreversible)
$-\underline{\tilde{\tau}}^T : \nabla \underline{v}$	kinetic	decrease in kinetic energy due to viscous heating (irreversible)
$\rho \underline{v} \cdot \underline{g}$	kinetic	increase in kinetic energy due to motion in gravity potential field
$-\rho \underline{v} \cdot \underline{g}$	potential	decrease in potential energy due to motion in gravity potential field
$k\nabla^2 T$	internal, total	heat flow in due to conduction
\mathcal{S}_e	internal, total	total heat flow in due to electrical current, chemical reaction

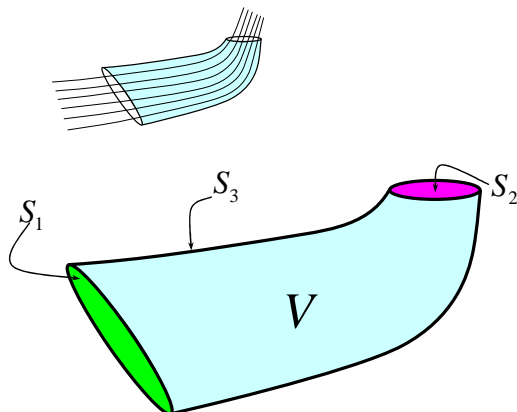

Figure D.2: Control volumes are regions of space that are chosen for convenience when solving problems in fluid mechanics and other fields of applied physics. The surface that bounds the control volume V is called the control surface $S = S_1 + S_2 + S_3$.

In the equation above, the forces in the summation are the forces on the control volume at time t , $\mathcal{P}(t)$ is the momentum of the fluid in the control volume, and the integral represents the net outflow of momentum through the control volume bounding surface S .

When we derived equation D.56 we did not allow the control volume to move or to change in size or shape. If S , the surface that encloses the control volume V , moves, then volume will be added to (or subtracted from) the size of the control volume. When the control volume increases in size, the momentum of the newly added fluid counts as additional momentum in the control volume. Likewise, when the control volume shrinks, there is a loss of momentum in the control volume due to the loss of fluid. We need to add a term to equation D.56 to include the net increase in control volume momentum that results from the movement of S .

The form of the Reynolds transport theorem given in equation D.56 emphasizes its origins in Newton's second law ($\sum \underline{f} = \text{other terms}$). Another way to understand the Reynolds transport theorem is as a momentum balance on the control volume.

$$\frac{d\mathcal{P}}{dt} = \sum_{\text{on CV}} \underline{f} - \iint_S (\hat{n} \cdot \underline{v}) \rho \underline{v} dS \quad (\text{D.57})$$

$$\left(\begin{array}{c} \text{rate of increase} \\ \text{of momentum} \\ \text{within CV} \end{array} \right) = \left(\begin{array}{c} \text{rate of increase} \\ \text{of momentum due} \\ \text{to forces on CV} \end{array} \right) + \left(\begin{array}{c} \text{rate of increase} \\ \text{of momentum due} \\ \text{to net flow in} \end{array} \right) \quad (\text{D.58})$$

Recall that \hat{n} is the outwardly pointing normal to the control surface S , and thus the integral in equation D.57 is net outflow of momentum from the control volume, and the negative sign converts that term to the net inflow.

In the momentum balance form of the Reynolds transport theorem (equation D.58),

the left-hand side is the rate of change of momentum, and all the contributions that increase the momentum are on the right-hand side. The missing term for the moving control volume case is an additional term on the right-hand side that captures the increase in momentum due to the addition of volume to V .

$$\begin{aligned} \left(\begin{array}{c} \text{rate of increase} \\ \text{of momentum} \\ \text{within CV} \end{array} \right) &= \left(\begin{array}{c} \text{rate of increase} \\ \text{of momentum due} \\ \text{to forces on CV} \end{array} \right) + \left(\begin{array}{c} \text{rate of increase} \\ \text{of momentum due to} \\ \text{net flow in} \end{array} \right) \\ &\quad + \left(\begin{array}{c} \text{rate of increase} \\ \text{of momentum due to} \\ \text{motion of } S(t) \end{array} \right) \end{aligned} \quad (\text{D.59})$$

$$\frac{d\mathcal{P}}{dt} = \sum_{\text{on CV}} \underline{f} - \iint_{S(t)} (\hat{n} \cdot \underline{v}) \rho \underline{v} dS + \left(\begin{array}{c} \text{rate of increase} \\ \text{of momentum due to} \\ \text{motion of } S(t) \end{array} \right) \quad (\text{D.60})$$

We can calculate the needed term from a surface integral involving \underline{v}_s , the local velocity of the surface, as we now show.

Our procedure closely follows the method used in appendix C.2.1.3 to calculate mass flow through a curved surface. First we divide S into convenient sub surfaces, for example S_1 , S_2 , S_3 (Figure D.2), and each section may be handled separately following the same procedure. Beginning with S_1 , the next step is to choose a coordinate system so that we can project the surface S_1 onto a chosen plane (the xy plane, Figure D.3). The area of the projection will be R . Since R is in the xy plane, the unit normal to R is \hat{e}_z . We divide the projection R the way we did in the mass-flow calculation (section C.2.1.3), into areas $\Delta A = \Delta x \Delta y$ and seek to write the momentum added to V by the motions of different regions of S_1 associated with the projections ΔA_i . By focusing on R and equal-sized divisions of R (rather than dividing S_1 directly), we can arrive at the appropriate integral expression.

Figure D.3 shows the area S_1 and its projection R in the xy plane. The area R has been divided into rectangles of area ΔA_i , and we will only consider the ΔA_i that are wholly contained within the boundaries of R .

For each ΔA_i in the xy plane we choose a point within ΔA_i , and we call this point $(x_i, y_i, 0)$. The point (x_i, y_i, z_i) is located directly above $(x_i, y_i, 0)$ on the surface S_1 . If we draw a plane tangent to S_1 through (x_i, y_i, z_i) , we can construct an area ΔS_i that is a portion of the tangent plane whose projection onto the xy plane is ΔA_i (Figure D.3). We will soon take a limit as ΔA_i becomes infinitesimally small, and therefore it is not important which point $(x_i, y_i, 0)$ is chosen so long as it is in ΔA_i .

Each tangent-plane area ΔS_i approximates a portion of the surface S_1 , and thus we can write the momentum added to V through the motion of S_1 as a sum of the momenta

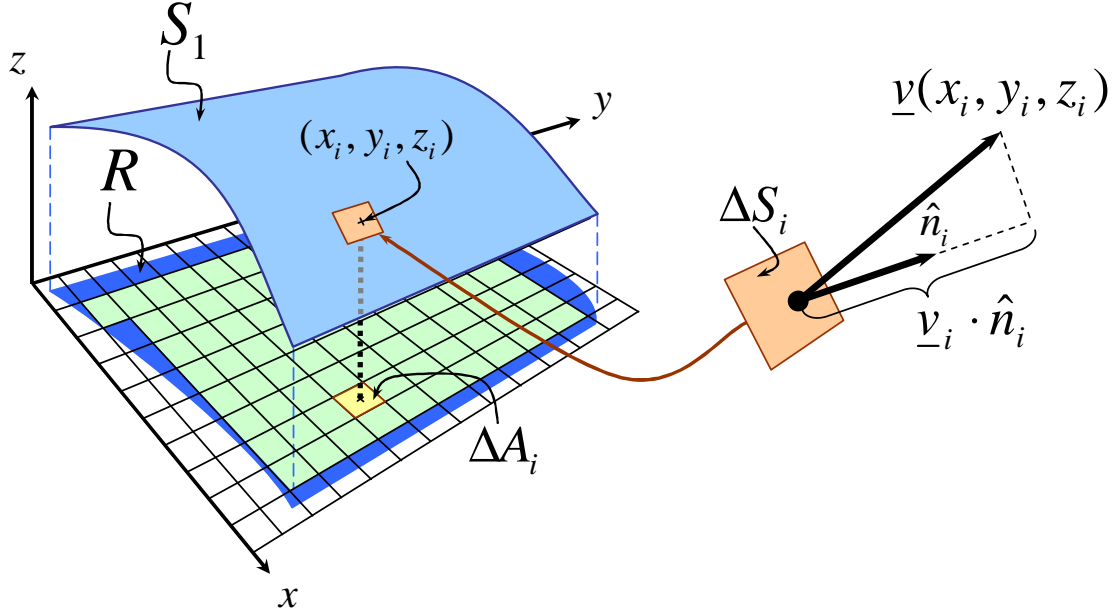

Figure D.3: For each portion of the surface S_1 , we first project the surface onto a plane called the xy plane. We then divide up the projection and proceed to write and sum up the momentum flow rate through each small piece. The surface differential ΔS can be related to ΔA , its projection onto the xy plane, by $\Delta S = \Delta A / (\hat{n} \cdot \hat{e}_z)$.

added by the motions of the individual regions ΔS_i .

$$\begin{pmatrix} \text{rate of increase} \\ \text{of momentum due to} \\ \text{motion of } S_1 \end{pmatrix} \approx \sum_{i=1}^N \begin{pmatrix} \text{rate of increase} \\ \text{of momentum due to} \\ \text{motion of } i^{\text{th}} \\ \text{tangent plane } \Delta S_i \end{pmatrix} \quad (\text{D.61})$$

$$\begin{pmatrix} \text{rate of increase} \\ \text{of momentum due to} \\ \text{motion of } S_1 \end{pmatrix} = \lim_{\Delta A \rightarrow 0} \sum_{i=1}^N \begin{pmatrix} \text{rate of increase} \\ \text{of momentum due to} \\ \text{motion of } i^{\text{th}} \\ \text{tangent plane } \Delta S_i \end{pmatrix} \quad (\text{D.62})$$

The momentum added through the motion of the individual ΔS_i may be written as

$$\left(\begin{array}{c} \text{rate of increase} \\ \text{of momentum due to} \\ \text{motion of } i^{\text{th}} \\ \text{tangent plane } \Delta S_i \end{array} \right) = \left(\frac{\text{momentum}}{\text{volume}} \right) \left(\frac{\text{volume added}}{\text{time}} \right) \quad (\text{D.63})$$

$$= (\rho_i \underline{v}_i) (\hat{n}_i \cdot \underline{v}_{s_i} \Delta S_i) \quad (\text{D.64})$$

where ρ_i is the fluid density near (x_i, y_i, z_i) , \underline{v}_i is the fluid velocity at the same point, and \underline{v}_{s_i} is the velocity of the tangent plane ΔS_i . Note that since \hat{n}_i is the outwardly pointing unit normal vector, when $\hat{n}_i \cdot \underline{v}_{s_i} > 0$, the volume of V will increase, and when $\hat{n}_i \cdot \underline{v}_{s_i} < 0$, the volume of V will decrease. We can take the result in equation D.64 and substitute it back into equation D.62 to obtain the rate of increase in momentum due to the motion of the surface S_1 .

$$\left(\begin{array}{c} \text{rate of increase} \\ \text{of momentum due to} \\ \text{motion of } S_1 \end{array} \right) = \lim_{\Delta A \rightarrow 0} \left[\sum_{i=1}^N (\rho_i \underline{v}_i) (\hat{n}_i \cdot \underline{v}_{s_i} \Delta S_i) \right] \quad (\text{D.65})$$

We can relate the tangent-plane area ΔS_i and the projected area ΔA_i through geometry (see Appendix C.4). The relationship is

$$\Delta A_i = (\hat{n}_i \cdot \hat{e}_z) \Delta S_i \quad (\text{D.66})$$

Substituting equation D.66 into equation D.65 we obtain

$$\left(\begin{array}{c} \text{rate of increase} \\ \text{of momentum due to} \\ \text{motion of } S_1 \end{array} \right) = \lim_{\Delta A \rightarrow 0} \left[\sum_{i=1}^N (\rho_i \underline{v}_i) (\hat{n}_i \cdot \underline{v}_{s_i}) \frac{\Delta A_i}{\hat{n}_i \cdot \hat{e}_z} \right] \quad (\text{D.67})$$

The right-hand side of equation D.67 is the definition of a double integral (see section C.2.1):

Double Integral of a function (general version)	$I = \iint_{\mathcal{R}} f(x, y) dA \equiv \lim_{\Delta A \rightarrow 0} \left[\sum_{i=1}^N f(x_i, y_i) \Delta A_i \right] \quad (\text{D.68})$
-------------------------------------------------------	--------------------------------------------------------------------------------------------------------------------------------------------------

By comparing equations D.67 and D.68 we can write

$$\left(\begin{array}{c} \text{rate of increase} \\ \text{of momentum due to} \\ \text{motion of } S_1 \end{array} \right) = \iint_{R(t)} (\hat{n} \cdot \underline{v}_s) \rho \underline{v} \frac{dA}{\hat{n} \cdot \hat{e}_z} \quad (\text{D.69})$$

$$= \iint_{S_1(t)} (\hat{n} \cdot \underline{v}_s) \rho \underline{v} dS \quad (\text{D.70})$$

where in the final step we have defined a new quantity $dS \equiv dA/(\hat{n} \cdot \hat{e}_z)$.

The results for S_2 and S_3 and any number of subdivisions of S are analogous. We can write all of these results together as double integral over the total control surface S .

$$\begin{aligned} \left(\begin{array}{l} \text{rate of momentum increase} \\ \text{due to motion of } S(t) \end{array} \right) &= \iint_{S_1(t)} (\hat{n} \cdot \underline{v}_s) \rho \underline{v} \, dS \\ &\quad + \iint_{S_2(t)} (\hat{n} \cdot \underline{v}_s) \rho \underline{v} \, dS \\ &\quad + \iint_{S_3(t)} (\hat{n} \cdot \underline{v}_s) \rho \underline{v} \, dS \end{aligned} \quad (\text{D.71})$$

$$= \iint_{S(t)} (\hat{n} \cdot \underline{v}_s) \rho \underline{v} \, dS \quad (\text{D.72})$$

This new result may be substituted into equation D.60 to complete the expression for the Reynolds transport theorem on moving control volumes.

$$\frac{d\mathcal{P}}{dt} = \sum_{\text{on CV}} \underline{f} - \iint_{S(t)} (\hat{n} \cdot \underline{v}) \rho \underline{v} \, dS + \iint_{S(t)} (\hat{n} \cdot \underline{v}_s) \rho \underline{v} \, dS \quad (\text{D.73})$$

We can simplify further if we rewrite \mathcal{P} in terms of an integral over our control volume.

$$\mathcal{P} = \iiint_{V(t)} \rho \underline{v} \, dV \quad (\text{D.74})$$

$$\frac{d\mathcal{P}}{dt} = \frac{d}{dt} \iiint_{V(t)} \rho \underline{v} \, dV \quad (\text{D.75})$$

For a moving and deforming volume $V(t)$, Leibniz rule for differentiating an integral (section C.5) allows us to expand the integral in equation D.75.

$$\frac{d\mathcal{P}}{dt} = \frac{d}{dt} \iiint_{V(t)} \rho \underline{v} \, dV = \iiint_{V(t)} \frac{\partial}{\partial t} (\rho \underline{v}) \, dV + \iint_{S(t)} (\hat{n} \cdot \underline{v}_s) \rho \underline{v} \, dS \quad (\text{D.76})$$

Two of the terms in equation D.76 appear in equation D.73, and we can combine the two equations and simplify.

Reynolds Transport Theorem (moving CV)	$\iiint_{V(t)} \frac{\partial}{\partial t} (\rho \underline{v}) \, dV = \sum_{\text{on CV}} \underline{f} - \iint_{S(t)} (\hat{n} \cdot \underline{v}) \rho \underline{v} \, dS \quad (\text{D.77})$
-------------------------------------------------	------------------------------------------------------------------------------------------------------------------------------------------------------------------------------------------------------

This is the final result for the momentum version of the Reynolds transport theorem when applied to a moving control volume.

D.4 Pressure Difference due to Surface Tension

The unbalanced intermolecular forces in a liquid near the fluid's surface give rise to surface tension (Chapter 4.4). Surface tension allows an interface to curve and the pressure is different on the two sides of a curved interface. We can calculate the pressure drop across an arbitrary, curved surface, if we imagine that an infinitely thin membrane covers the surface. The tension per unit length in this imaginary thin membrane is given by σ , the surface tension, which has units of force per unit length.

Consider the momentum balance on a control volume that encloses a piece of a curved interface as shown in Figure D.4. To describe the shape of the interface, we define two local

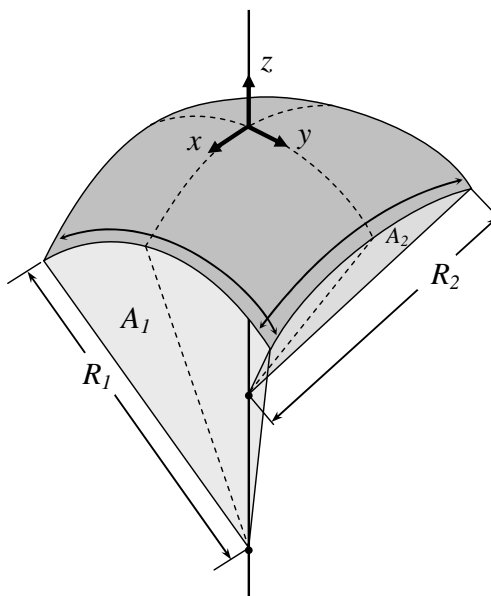

Figure D.4: For a surface of complex shape, we can relate the local pressures on the two sides of the surface to the surface tension with the aid of the sketch above.

radii of curvature, R_1 and R_2 . The center of the surface is the origin of our chosen cartesian coordinate system, with the z -direction pointed upwards. The shape of the interface can be described in terms of two arcs. From a point on the z -axis a distance R_1 in the $(-z)$ -direction, a line of length R_1 swings first in the $(-y)$ -direction through an angle $-\theta_1$ and then in the $(+y)$ -direction through an angle $+\theta_1$. Similarly in the xz -plane, from a point on the z -axis a distance R_2 in the $(-z)$ -direction, a line of length R_2 swings first in the $(-x)$ -direction through an angle $-\theta_2$ and then in the $(+x)$ -direction through an angle $+\theta_2$. The two-dimensional surface spanned by these two swinging lines is the surface element we will consider.

The surface element described is not physically realizable, since at the corners (near the four points $(\pm R_2\theta_2, \pm R_1\theta_1, 0)$) the two spanning arcs do not meet correctly. We are considering the situation where the angles θ_1 and θ_2 are very small, and therefore the approximations involved in this aspect of the geometry is not a problem for the derivation.

The projection of the surface element onto the xy -plane is a rectangle of sides approximately equal to the arc lengths, $R_1(2\theta_1)$ and $R_2(2\theta_2)$. We choose our control volume to be a rectangular parallelepiped of cross section equal to the z -projection of the surface element. The heights of the control volume in the $\pm z$ -directions are arbitrary, but they are chosen to be sufficient to enclose the surface.

The momentum balance we use is the Reynolds transport theorem. The surface is motionless, and thus $\underline{v} = 0$, $\mathcal{P} = 0$, and the momentum balance tells us that the sum of the forces on the control volume must be zero.

$$\frac{d\mathcal{P}}{dt} = \sum_{\text{on CV}} \underline{f} - \iint_S (\hat{n} \cdot \underline{v}) \rho \underline{v} dS \quad (\text{D.78})$$

$$0 = \sum_{\text{on CV}} \underline{f} \quad (\text{D.79})$$

There are two forces acting on the control volume, pressure and surface tension. The components of these forces in the x - and y -directions are equal and opposite in the $(\pm x)$ - and $(\pm y)$ -directions and exactly balance. We will therefore concern ourselves with the z -component of the momentum balance.

The fluid pressure on the bottom of the control volume p_{in} acts on the control volume in the \hat{e}_z -direction, while the fluid pressure on the top of the control volume p_{out} acts on the control volume in the $(-\hat{e}_z)$ -direction.

$$\begin{aligned} \begin{pmatrix} z\text{-direction} \\ \text{force due to} \\ \text{inside pressure} \end{pmatrix} &= (\text{pressure})(\text{area}) \begin{pmatrix} \text{unit vector} \\ \text{indicating} \\ \text{direction} \end{pmatrix} \\ &= p_{in}(2\theta_1 R_1)(2\theta_2 R_2)\hat{e}_z \end{aligned} \quad (\text{D.80})$$

$$\begin{pmatrix} z\text{-direction} \\ \text{force due to} \\ \text{outside pressure} \end{pmatrix} = p_{out}(2\theta_1 R_1)(2\theta_2 R_2)(-\hat{e}_z) \quad (\text{D.81})$$

The force due to surface tension on our surface element can be thought of as the force applied to the corners of a massless membrane that occupies the surface. This massless membrane is like a sail secured by eight ropes at the corners of the sail (Figure D.5). There are four edges of the surface to consider, two formed by the sweeping of the R_1 -line through the angle θ_1 , and two formed by the sweeping of the R_2 -line through the angle θ_2 .

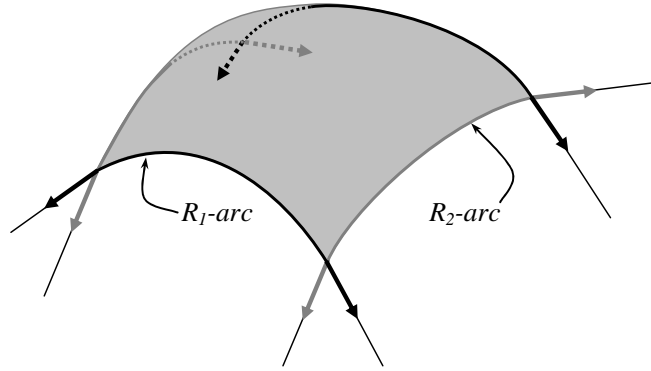

Figure D.5: The effect of surface tension on our surface element can be thought of as the tension on eight ropes securing as sail of the same shape.

To calculate the z -component of the surface tension force on the edge formed by the sweeping R_1 -line, consider the section through the origin of the xz -plane shown in Figure D.7. The line R_2 sweeps out in this plane and reaches its maximum extent at an angle of θ_2 . At that point of maximum extent, the line R_2 touches the arc made by the line R_1 sweeping in an orthogonal direction. Thus, the distance from this point back to the z -axis is just R_1 . The point at which this line touches the z axis is the point $(0, 0, -R_1)$. The plane that contains this line and the y -direction is shown in Figure D.6. We will call this plane A_1 .

Within plane A_1 the line R_1 sweeps out an arc. We can calculate the surface tension force at either end of this arc with the help of Figure D.6. The tension applied to the arc acts tangentially to the ends of the arc as shown. The vector indicating the direction of the surface tension can be written as

$$\begin{array}{l} \text{Direction of} \\ \text{surface tension} \\ \text{at one end of} \\ R_1\text{-arc in } A_1 \end{array} \quad \underline{s}_1 = \cos \theta_1 \hat{e}_y - \sin \theta_1 \hat{e}_{z''} \quad (\text{D.82})$$

where $\hat{e}_{z''}$ is the direction indicated in Figure D.6. We can relate the unit vector $\hat{e}_{z''}$ to the xyz -coordinate system by reference to the xz -plane also sketched in Figure D.6.

$$\hat{e}_{z''} = \sin \alpha \hat{e}_x + \cos \alpha \hat{e}_z \quad (\text{D.83})$$

$$R_1 \sin \alpha = R_2 \sin \theta_2 \quad (\text{D.84})$$

$$\alpha = \sin^{-1} (R_2/R_1) \sin \theta_2 \quad (\text{D.85})$$

We can substitute this result into equation D.82 and obtain \underline{s}_1 .

$$\begin{array}{l} \text{Direction of} \\ \text{surface tension} \\ \text{at one end of} \\ R_1\text{-arc in } A_1 \end{array} \quad \underline{s}_1 = \cos \theta_1 \hat{e}_y - (\sin \theta_1 \sin \alpha) \hat{e}_x - (\sin \theta_1 \cos \alpha) \hat{e}_z \quad (\text{D.86})$$

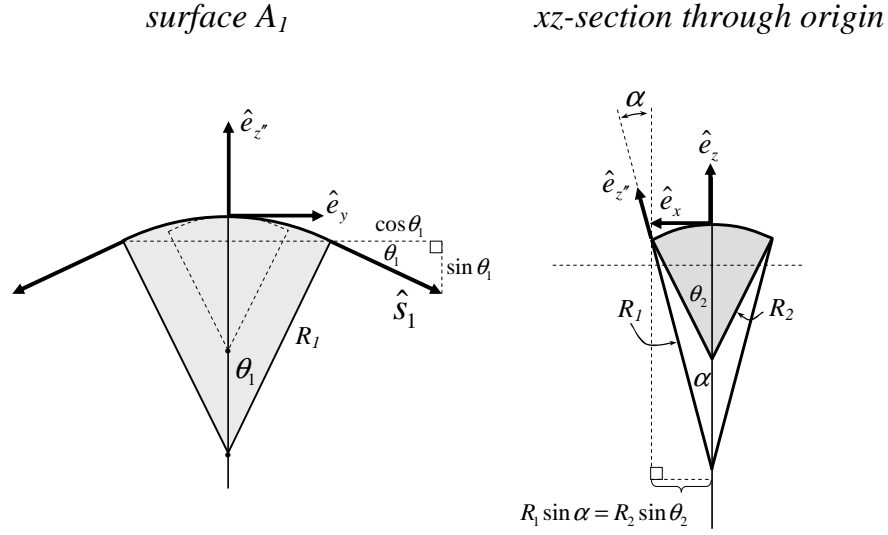

Figure D.6: A detail of the plane (surface A_1) at an angle $\alpha = \sin^{-1}(R_2/R_1) \sin \theta_2$ to the yz -plane through the point $(0, 0, -R_1)$ and a section of the xz -plane through the origin. These sketches help to elucidate the geometric relations between the vectors in the derivation.

The surface tension at one end of the R_1 -arc in A_1 can now be calculated as follows.

$$\begin{pmatrix} \text{force} \\ \text{due to} \\ \text{surface} \\ \text{tension} \end{pmatrix} = \begin{pmatrix} \text{force/length} \\ \text{along} \\ \text{circumference} \end{pmatrix} (\text{length}) \begin{pmatrix} \text{unit vector} \\ \text{indicating} \\ \text{direction} \end{pmatrix} \quad (\text{D.87})$$

$$= \sigma(\theta_1 R_1) \underline{s}_1 \quad (\text{D.88})$$

The z -component of the surface tension force is just the term of s_1 that contains \hat{e}_z . The surface tension acts at both ends of the R_1 -arc in A_1 , and thus we multiply this expression by two. Also, there are two R_1 -arcs in our surface, and thus we multiply again by two to get the total z -directed surface-tension force due to R_1 -arcs.

$$\begin{aligned} & z\text{-directed} \\ & \text{surface-tension} \\ & \text{force due to two} \\ & R_1\text{-arcs in surface} \end{aligned} = -4\sigma R_1 \theta_1 \sin \theta_1 \cos \alpha \hat{e}_z \quad (\text{D.89})$$

Using the plane A_2 sketched in Figure D.7, a similar calculation can be made to obtain the z -directed surface-tension force due to the two R_2 -arcs. The results are given below.

$$\underline{s}_2 = \cos \theta_2 \hat{e}_x - (\sin \theta_2 \sin \beta) \hat{e}_y - (\sin \theta_2 \cos \beta) \hat{e}_z \quad (\text{D.90})$$

$$R_2 \sin \beta = R_1 \sin \theta_1 \quad (\text{D.91})$$

$$\beta = \sin^{-1}(R_1/R_2) \sin \theta_1 \quad (\text{D.92})$$

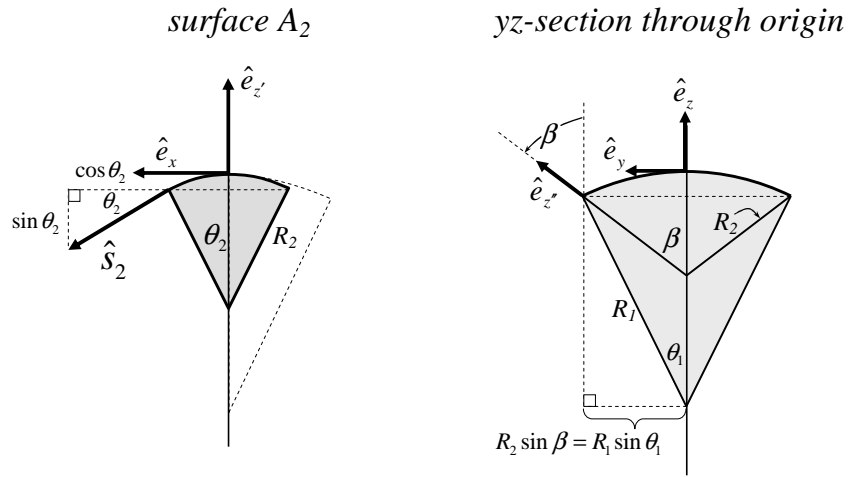

Figure D.7: A detail of the plane at an angle $\beta = \sin^{-1}(R_1/R_2) \sin \theta_1$ to the xz -plane through the point $(0, 0, -R_2)$, and a section of the yz -plane through the origin. Note that the maximum value of $\sin \beta$ is one, and thus $\sin \theta_1 < R_2/R_1$.

$$\begin{aligned}
 & z\text{-directed} \\
 & \text{surface-tension} \\
 & \text{force due to two} \\
 & R_2\text{-arcs in surface}
 \end{aligned}
 = -4\sigma R_2 \theta_2 \sin \theta_2 \cos \beta \hat{e}_z \tag{D.93}$$

We now return to equation D.79 and assemble the force balance.

$$0 = \sum_{\text{on CV}} (\hat{e}_z \cdot \underline{f}) \quad (z\text{-component}) \tag{D.94}$$

$$\begin{aligned}
 0 = & p_{in}(2\theta_1 R_1)(2\theta_2 R_2) - p_{out}(2\theta_1 R_1)(2\theta_2 R_2) \\
 & -4\sigma R_1 \theta_1 \sin \theta_1 \cos \alpha - 4\sigma R_2 \theta_2 \sin \theta_2 \cos \beta
 \end{aligned} \tag{D.95}$$

Since θ_1 and θ_2 are arbitrary, we can now take $\theta_1 = \theta_2 = \theta$; further we assume that θ is small enough that we can approximate $\sin \theta \approx \theta$, $\cos \alpha \approx 1$, and $\cos \beta \approx 1$. With these assumptions, we obtain the final result.

$$\boxed{\Delta p = p_{in} - p_{out} = \sigma \left(\frac{1}{R_1} + \frac{1}{R_2} \right)} \tag{D.96}$$

This equation is known as the Young-Laplace equation. Note that for $R_1 = R_2$, the Young-Laplace equation gives the spherical bubble result, equation 4.413. For $R_2 \rightarrow 0$, equation D.96 applies to a cylindrical jet of fluid.

D.5 Wall Drag in a Noncircular Duct

In Chapter 9 we calculated the wall drag on a tube of circular cross section. We can apply the same steps to arrive at the analogous result for tubes with non-circular cross-sections, as we show in the example that follows.

EXAMPLE D.1 *What is the total drag force on the wall for a Newtonian fluid of viscosity μ flowing in a horizontal, non-circular conduit under pressure (Figure D.8)? Over a length L the pressure drops from p_0 to p_L ; the flow may be laminar or turbulent.*

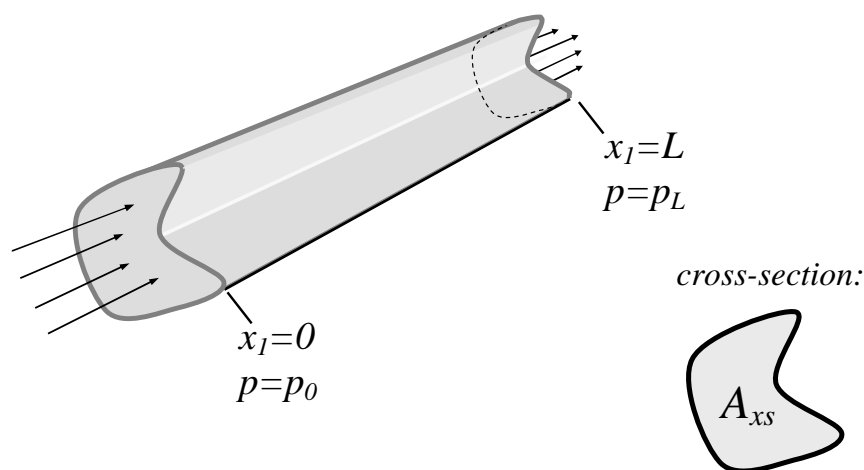

Figure D.8: Unidirectional flow in a pipe of arbitrary cross-sectional shape may be analyzed using the macroscopic momentum balance. The results may be specialized to a particular case once the geometry is known.

SOLUTION The macroscopic momentum balance on a control volume is

$$\begin{array}{l} \text{Reynolds transport} \\ \text{theorem} \\ \text{(momentum balance} \\ \text{on a CV)} \end{array} \quad \frac{d\mathbf{P}}{dt} = - \iint_S (\hat{\mathbf{n}} \cdot \underline{\mathbf{v}}) \rho \underline{\mathbf{v}} dS + \sum_{\text{on CV}} \underline{\mathbf{f}} \quad (\text{D.97})$$

We apply this macroscopic balance in a Cartesian coordinate system with the flow in the x_1 -direction. Following the steps used for tube flow in the example that

led to equation 7.117, we make the following substitutions to make the derivation applicable to non-circular conduits.

	circular	non-circular	
differential area	$r dr d\theta$	dA	(D.98)
cross-sectional area	πR^2	A_{xs}	

Thus, for a non-circular conduit

$$\langle v \rangle = \frac{\dot{V}}{A_{xs}} \quad (\text{D.99})$$

where $\langle v \rangle$ is the average velocity and \dot{V} is the volumetric flow rate. For the control volume we choose the same control volume as was used for flow in pipes, a volume of length L enclosing the fluid between $x_1 = 0$ and $x_1 = L$.

The convective term (the integral in equation D.97) is zero for non-circular ducts as it was for circular ducts, because the same amount of fluid flows into and out of the control volume. Also, the flow is steady ($d\underline{\mathbf{P}}/dt = 0$), leaving

$$0 = \sum_{\text{on CV}} \underline{f} \quad (\text{D.100})$$

The forces on the control volume are also the same in the two cases, with the appropriate substitutions made for the differences in conduit shape. The molecular force terms acting on the ends of the control volume (top and bottom of the conduit) are calculated from equation 7.104, repeated below, following the same steps as were used for tube flow.

$$\begin{aligned} \text{Total fluid force} &= \iint_{\mathcal{S}} [\hat{n} \cdot \underline{\underline{\tilde{\Pi}}}]_{\text{at surface}} dS & (\text{D.101}) \\ \text{on a surface } \mathcal{S} & \end{aligned}$$

$$= \iint_{\mathcal{S}} [\hat{n} \cdot (-p\underline{\underline{I}} + \underline{\underline{\tilde{\tau}}})]_{\text{at surface}} dS \quad (\text{D.102})$$

$$= \iint_{\mathcal{S}} [-p\hat{n} + \hat{n} \cdot \underline{\underline{\tilde{\tau}}}]_{\text{at surface}} dS \quad (\text{D.103})$$

The expression for $\underline{\underline{\tilde{\Pi}}}$ for laminar flow in non-circular ducts is given by equation 7.181. For turbulent flows, the equation for $\underline{\underline{\tilde{\Pi}}}$ is the same as for the laminar case with the velocity derivatives replace with the fluctuation-averaged analogues

(see appendix 10.3 for details on fluctuation-averaging).

$$\underline{\tilde{\Pi}} = -p\underline{I} + \underline{\tilde{\tau}} = -p\underline{I} + \mu (\nabla \underline{v} + (\nabla \underline{v})^T) \quad (\text{D.104})$$

$$= \begin{pmatrix} -p & \mu \frac{\partial \overline{v_1}}{\partial x_2} & \mu \frac{\partial \overline{v_1}}{\partial x_3} \\ \mu \frac{\partial \overline{v_1}}{\partial x_2} & -p & 0 \\ \mu \frac{\partial \overline{v_1}}{\partial x_3} & 0 & -p \end{pmatrix}_{123} \quad (\text{D.105})$$

$$\begin{array}{l} \text{Total fluid force} \\ \text{on surface } a \end{array} = \iint_{A_{xs}} [\hat{n} \cdot \underline{\tilde{\Pi}}]_a dA \quad (\text{D.106})$$

$$= \iint_{A_{xs}} \begin{pmatrix} -1 & 0 & 0 \end{pmatrix}_{123} \cdot \underline{\tilde{\Pi}}|_a dA \quad (\text{D.107})$$

$$= \iint_{A_{xs}} \begin{pmatrix} p|_a \\ -\frac{\partial \overline{v_1}}{\partial x_2} \Big|_a \\ -\frac{\partial \overline{v_1}}{\partial x_3} \Big|_a \end{pmatrix}_{123} dA \quad (\text{D.108})$$

$$\begin{array}{l} \text{Total fluid force} \\ \text{on surface } b \end{array} = \iint_{A_{xs}} [\hat{n} \cdot \underline{\tilde{\Pi}}]_b dA \quad (\text{D.109})$$

$$= \iint_{A_{xs}} \begin{pmatrix} 1 & 0 & 0 \end{pmatrix}_{123} \cdot \underline{\tilde{\Pi}}|_b dA \quad (\text{D.110})$$

$$= \iint_{A_{xs}} \begin{pmatrix} -p|_b \\ \frac{\partial \overline{v_1}}{\partial x_2} \Big|_b \\ \frac{\partial \overline{v_1}}{\partial x_3} \Big|_b \end{pmatrix}_{123} dA \quad (\text{D.111})$$

The macroscopic momentum balance is then

$$0 = \sum_{\text{on CV}} \underline{f} \quad (\text{D.112})$$

where the forces are the molecular forces (from pressure and viscosity) and non-

contact body forces (gravity). The macroscopic momentum balance thus becomes

$$\begin{pmatrix} 0 \\ 0 \\ 0 \end{pmatrix}_{123} = M_{CV} \begin{pmatrix} 0 \\ 0 \\ g_3 \end{pmatrix}_{123} + \begin{pmatrix} R_1 \\ R_2 \\ R_3 \end{pmatrix}_{123} + \begin{pmatrix} A_{xs}p_0 \\ \iint_{A_{xs}} -\mu \frac{\partial \bar{v}_1}{\partial x_2} \Big|_a dA \\ \iint_{A_{xs}} -\mu \frac{\partial \bar{v}_1}{\partial x_3} \Big|_a dA \end{pmatrix}_{123} + \begin{pmatrix} -A_{xs}p_L \\ \iint_{A_{xs}} \mu \frac{\partial \bar{v}_1}{\partial x_2} \Big|_b dA \\ \iint_{A_{xs}} \mu \frac{\partial \bar{v}_1}{\partial x_3} \Big|_b dA \end{pmatrix}_{123} \quad (\text{D.113})$$

For well-developed flow the velocity profile does not vary down the length of the conduit and $\partial \bar{v}_1 / \partial x_2|_a = \partial \bar{v}_1 / \partial x_2|_b$ and $\partial \bar{v}_1 / \partial x_3|_a = \partial \bar{v}_1 / \partial x_3|_b$, as before. The integrals that contain the 2- and 3-components simplify in equation D.113 as

$$\text{2-component:} \quad R_2 = 0 \quad (\text{D.114})$$

$$\text{3-component:} \quad R_3 = -M_{CV}g_3 \quad (\text{D.115})$$

The 1-component of the macroscopic momentum balance gives us the desired expression for the total drag force on the walls.

$$\text{1-component:} \quad 0 = R_1 + A_{xs}p_0 - A_{xs}p_L \quad (\text{D.116})$$

$$\mathcal{F}_{\text{drag}} = -R_1 = (p_0 - p_L)A_{xs} \quad (\text{D.117})$$

Axial drag in
laminar flow in
duct of constant
cross-section

$$\mathcal{F}_{\text{drag}} = (p_0 - p_L)A_{xs} \quad (\text{D.118})$$

This is the same result as was obtained for the circular pipe ($\mathcal{F}_{\text{drag}} = \pi R^2 \Delta p$), equation 7.117) and for the slit and for the rectangular duct ($\mathcal{F}_{\text{drag}} = (\text{width} \cdot \text{height}) \Delta p$, equations 7.207 and 7.232).

D.6 Turbulent Flow in Non-Circular Ducts

As we did with pipes, we begin with velocity and derive an expression for the drag force on the walls of the pipe. Fundamentally the friction-factor/Reynolds-number relationship correlates the drag force on the walls of the conduits with the speed of the flow.

For turbulent flow in a tube, the velocity vector has three non-zero components that vary in all three coordinate directions and with time.

$$\text{Turbulent pipe flow: } \underline{v} = \begin{pmatrix} v_r(r, \theta, z, t) \\ v_\theta(r, \theta, z, t) \\ v_z(r, \theta, z, t) \end{pmatrix}_{r\theta z} \quad (\text{D.119})$$

The equations that we need to solve for velocity are the continuity equation and the equation of motion (microscopic momentum balance).

$$\text{Mass conservation: } 0 = \nabla \cdot \underline{v} \quad (\text{D.120})$$

$$\text{Momentum conservation: } \rho \left(\frac{\partial \underline{v}}{\partial t} + \underline{v} \cdot \nabla \underline{v} \right) = -\nabla p + \mu \nabla^2 \underline{v} + \rho \underline{g} \quad (\text{D.121})$$

We obtain these equations written in cylindrical coordinates from Tables B.8 and B.10 in the appendix.

Once the velocity solution is calculated, we obtain the fluid drag on the walls by employing the general expression for stress on a surface in a flow.

$$\begin{array}{l} \text{Total force} \\ \text{in a fluid} \\ \text{on a surface } S \end{array} = \iint_S \left[\hat{n} \cdot \underline{\underline{\tilde{\Pi}}}\right]_{\text{at surface}} dS \quad (\text{D.122})$$

To carry out the calculation in equation D.122 we need the stress tensor $\underline{\underline{\tilde{\Pi}}}$ for our flow, and information on the shape of the wall surfaces. The stress tensor is given by

$$\text{Stress tensor: } \underline{\underline{\tilde{\Pi}}} = -p\underline{\underline{I}} + \underline{\underline{\tilde{\tau}}} \quad (\text{D.123})$$

$$= \begin{pmatrix} \tau_{rr} - p & \tau_{r\theta} & \tau_{rz} \\ \tau_{\theta r} & \tau_{\theta\theta} - p & \tau_{\theta z} \\ \tau_{zr} & \tau_{z\theta} & \tau_{zz} - p \end{pmatrix}_{r\theta z} \quad (\text{D.124})$$

We are deriving an expression for a conduit of arbitrary cross section. Let S_{xs} be the area of the cross-section of the conduit, and \mathcal{P} be the curve in the r - θ -plane that encloses S_{xs} (the perimeter) (Figure D.9). The surface we are interested in is the inside surface of the pipe. If dC is a small piece of the perimeter of the conduit, \hat{n} in equation D.122 is $-\hat{c}$, the inwardly pointing unit normal vector associated with dC . Because it is a unit normal in the plane of the cross-section, the z -component of \hat{n} is zero.

$$\begin{array}{l} \text{Axial fluid drag} \\ \text{on a} \\ \text{conduit surface} \end{array} \mathcal{F}_{\text{drag}} = \iint_{\mathcal{P}L} \hat{e}_z \cdot \left(-\hat{c} \cdot \underline{\underline{\tilde{\Pi}}}\Big|_{\mathcal{P}} \right) dS \quad (\text{D.125})$$

$$= \iint_{\mathcal{P}L} \begin{pmatrix} 0 \\ 0 \\ 1 \end{pmatrix}_{r\theta z} \cdot \left[\left(-c_r \quad -c_\theta \quad 0 \right)_{r\theta z} \cdot \underline{\underline{\tilde{\Pi}}}\Big|_{\mathcal{P}} \right] dS \quad (\text{D.126})$$

$$= \iint_{\mathcal{P}L} - \left(c_r \tau_{rz} \Big|_{\mathcal{P}} + c_\theta \tau_{\theta z} \Big|_{\mathcal{P}} \right) dS \quad (\text{D.127})$$

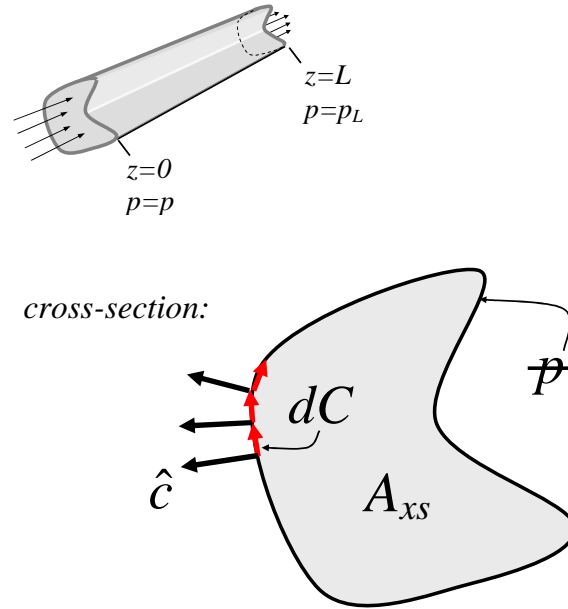

Figure D.9: A conduit of arbitrary cross-sectional shape can be analyzed in terms of the general geometry given above.

We arrived at the simplified expression in equation D.127 by using matrix calculations to carry out the dot products in equation D.126; $\tilde{\Pi}$ is obtained from equation D.124.

The shear stresses τ_{rz} and $\tau_{\theta z}$ are related to the velocity field through the Newtonian constitutive equation, Table B.11.

$$\text{Newtonian constitutive eqn:} \quad \underline{\tilde{\tau}} = \mu(\nabla \underline{v} + (\nabla \underline{v})^T) \quad (\text{D.128})$$

$$rz\text{-component of } \underline{\tilde{\tau}}: \quad \tau_{rz} = \mu \left(\frac{\partial v_z}{\partial r} + \frac{\partial v_r}{\partial z} \right) \quad (\text{D.129})$$

$$\theta z\text{-component of } \underline{\tilde{\tau}}: \quad \tau_{\theta z} = \mu \left(\frac{1}{r} \frac{\partial v_z}{\partial \theta} + \frac{\partial v_\theta}{\partial z} \right) \quad (\text{D.130})$$

Thus, substituting these expressions into equation D.127 we obtain the analytical expression for the axial drag in a non-circular conduit in turbulent flow.

$$\mathcal{F}_{\text{drag}} = \iint_{pL} - \left(c_r \tau_{rz}|_p + c_\theta \tau_{\theta z}|_p \right) dS \quad (\text{D.131})$$

$$= \iint_{pL} -\mu \left[c_r \left(\frac{\partial v_z}{\partial r} + \frac{\partial v_r}{\partial z} \right) + c_\theta \left(\frac{1}{r} \frac{\partial v_z}{\partial \theta} + \frac{\partial v_\theta}{\partial z} \right) \right] \Big|_p dS \quad (\text{D.132})$$

The derivatives in equation D.132 come from the turbulent velocity field $\underline{v}(r, \theta, z)$. For our conduit of constant cross-section the surface-area element dS can be written in terms of dC as $dS = dC dz$.

We now non-dimensionalized the equation for $\mathcal{F}_{\text{drag}}$ in the usual way. The friction factor is defined as

$$f \equiv \frac{\mathcal{F}_{\text{drag}}}{\frac{1}{2}\rho V^2 \frac{D}{L}} \quad (\text{D.133})$$

Incorporating this and the usual relations for dimensionless velocities and distance we obtain

$$\frac{f\rho V^2 \frac{D}{L}}{2} = \frac{\mu V D^2}{D} \int_0^1 \int_0^1 - \left[c_r \left(\frac{\partial v_z^*}{\partial r^*} + \frac{\partial v_r^*}{\partial z^*} \right) + c_\theta \left(\frac{1}{r^*} \frac{\partial v_z^*}{\partial \theta} + \frac{\partial v_\theta^*}{\partial z^*} \right) \right] \Big|_{\mathcal{P}^*} dC^* dz^* \quad (\text{D.134})$$

$$f = \frac{\mu}{\rho V D} \frac{D}{L} \frac{1}{2} \int_0^1 \int_0^1 - \left[c_r \left(\frac{\partial v_z^*}{\partial r^*} + \frac{\partial v_r^*}{\partial z^*} \right) + c_\theta \left(\frac{1}{r^*} \frac{\partial v_z^*}{\partial \theta} + \frac{\partial v_\theta^*}{\partial z^*} \right) \right] \Big|_{\mathcal{P}^*} dC^* dz^* \quad (\text{D.135})$$

$$f = \frac{1}{Re} \frac{D}{L} \frac{1}{2} \int_0^1 \int_0^1 - \left[c_r \left(\frac{\partial v_z^*}{\partial r^*} + \frac{\partial v_r^*}{\partial z^*} \right) + c_\theta \left(\frac{1}{r^*} \frac{\partial v_z^*}{\partial \theta} + \frac{\partial v_\theta^*}{\partial z^*} \right) \right] \Big|_{\mathcal{P}^*} dC^* dz^* \quad (\text{D.136})$$

The conclusions we draw from equation D.136 are the same as we drew from equation 7.139, the expression for drag in a pipe. The terms in the integral come from the solution to the momentum balance, and thus are a function of Re and Fr . We can therefore write the integral as $\Phi(Re, Fr)$ and simplify the result for f as

$$f = \frac{1}{Re} \frac{D}{L} \frac{1}{2} \Phi(Re, Fr) \quad (\text{D.137})$$

Experiments can be performed to obtain the exact functional form of $\Phi(Re, Fr)$, and those experiments show that Fr is not important in internal flows. Thus friction factor is only a function of Reynolds number.

D.7 Quasi-static, Adiabatic Expansion of an Ideal Gas

This is a standard derivation from physics or thermodynamics. This presentation follows that of Tipler[186].

In Chapter 10 we discussed compressible fluid flow and used the expression for the relationship between pressure and volume in an ideal gas that is expanding quasi-statically and adiabatically.

$$pV^\gamma = \text{constant} \quad (\text{D.138})$$

Equation D.138 can be derived by considering an ideal gas in a container where one wall is a movable piston (see Figure D.10). The entire container is well insulated so no heat can escape or enter the container - these are the conditions of an adiabatic process. The gas can change volume only by giving up some of its internal energy, i.e. by decreasing in temperature. The exchange of energy between internal energy (proportional to temperature) and volume is governed by the first law of thermodynamics and the ideal gas law. Beginning

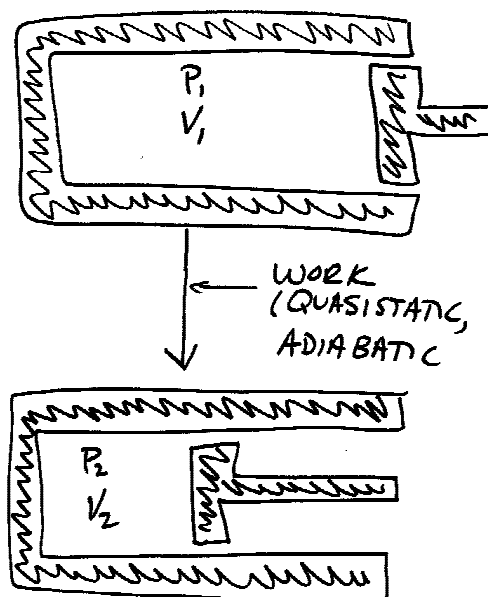

Figure D.10: To derive the $P - V$ relationship for a gas that is expanding quasi-statically and adiabatically, consider an ideal gas in a container. The container has a piston as one wall, and the volume that the gas occupies varies throughout the expansion.

with the ideal gas law $pV = nRT$, we differentiate to obtain an expression that indicates how changes in pressure, volume, and temperature are related in ideal gases.

$$pdV + Vdp = nRdT \quad (\text{D.139})$$

Note that the number of moles of gas in the container is constant since it is a closed container. We are interested in the $P - V$ relationship, and we can eliminate temperature changes from equation D.139 by considering the constraints imposed by the first law of thermodynamics.

The first law states that heat flows (dQ) are balanced by changes in internal energy (dU) and work done by the system (dW).

$$\boxed{dQ = dU + dW} \quad \text{First Law of Thermodynamics} \quad (\text{D.140})$$

For an adiabatic process dQ is zero. A quasi-static process is one that moves infinitesimally slowly and is therefore reversible. For such a process the work dW is just force times

displacement (no irreversible work) and is therefore equal to pdV . Thus the first law becomes

$$0 = dU + pdV \quad \begin{array}{l} \text{First Law of Thermodynamics} \\ \text{Quasi-Static Adiabatic Processes} \end{array} \quad (\text{D.141})$$

The internal energy of a gas is related to temperature through the definition of the heat capacity at constant volume, C_v : $dU = C_v dT$. We can thus write the first law for quasi-static adiabatic processes in terms of temperature changes and C_v .

$$0 = C_v dT + pdV \quad (\text{D.142})$$

This is an equation that tells us how temperature changes and volume changes are inter-related in quasi-static adiabatic process. We can solve equation D.142 for dT and then substitute it into the differentiated ideal gas law to yield an equation that relates p and V directly for these processes, with no explicit mention of T or dT .

$$\begin{aligned} dT &= \frac{-pdV}{C_v} && \text{from equation D.142} \\ pdV + Vdp &= nRdT && \text{ideal gas law in differential form} \\ &= nR \frac{-pdV}{C_v} && (\text{D.143}) \end{aligned}$$

We now combine the terms with dV in equation D.143 and make the substitution of the thermodynamic relationship between C_v and C_p , $C_v + nR = C_p$, and simplify.

$$pdV + nR \frac{pdV}{C_v} + Vdp = 0 \quad (\text{D.144})$$

$$\left(1 + \frac{nR}{C_v}\right) pdV + Vdp = 0 \quad (\text{D.145})$$

$$(C_v + nR) pdV + C_v V dp = 0 \quad (\text{D.146})$$

$$(C_p) pdV + C_v V dp = 0 \quad (\text{D.147})$$

$$\frac{C_p}{C_v} \frac{dV}{V} + \frac{dp}{p} = 0 \quad (\text{D.148})$$

The ratio C_p/C_v is given the symbol γ . Equation D.148 may be integrated directly.

$$\gamma \frac{dV}{V} + \frac{dp}{p} = 0 \quad (\text{D.149})$$

$$\gamma \ln V + \ln p = C_1 \quad (\text{D.150})$$

where C_1 is an integration constant. The final result is obtained after a little bit of algebra.

$$\ln V^\gamma + \ln p = C_1 \quad (\text{D.151})$$

$$\ln(pV^\gamma) = C_1 \quad (\text{D.152})$$

$pV^\gamma = \text{constant}$

$$\begin{array}{l} p - V \text{ Relationship for an} \\ \text{Ideal Gas Undergoing a} \\ \text{Quasi-Static Adiabatic Process} \end{array} \quad (\text{D.153})$$