

**Topics for Today:**

- Announcements
  - Term Project - select journal paper and outline. Completed analysis due end of Week 12. Submit via e-mail as “mini-lecture” .ppt with voice narration.
  - ASPEN software - runs off of MTU server via internet.
  - Office: EERC 614.
  - Recommended problems & all solutions: Ch.9 solns now posted.
  - Upcoming material: balanced 3-phase issues: powerflow, operation.
  - After that: Unbalanced 3-phase short circuit analysis.
- Chapter 9 - Powerflow
  - [Ybus] used for powerflow does not include Norton generator admittance.
  - Generator viewed as an ideal source of P and Q.
  - P-Q formulation using [Ybus] - See NRFL.pdf handout
  - Running a powerflow - slack, P-Q (or load), P-V (or gen) buses
  - Simulation output - line flows, generator output, limits, etc.
  - Line loading limits

$[Y_{Bus}]$

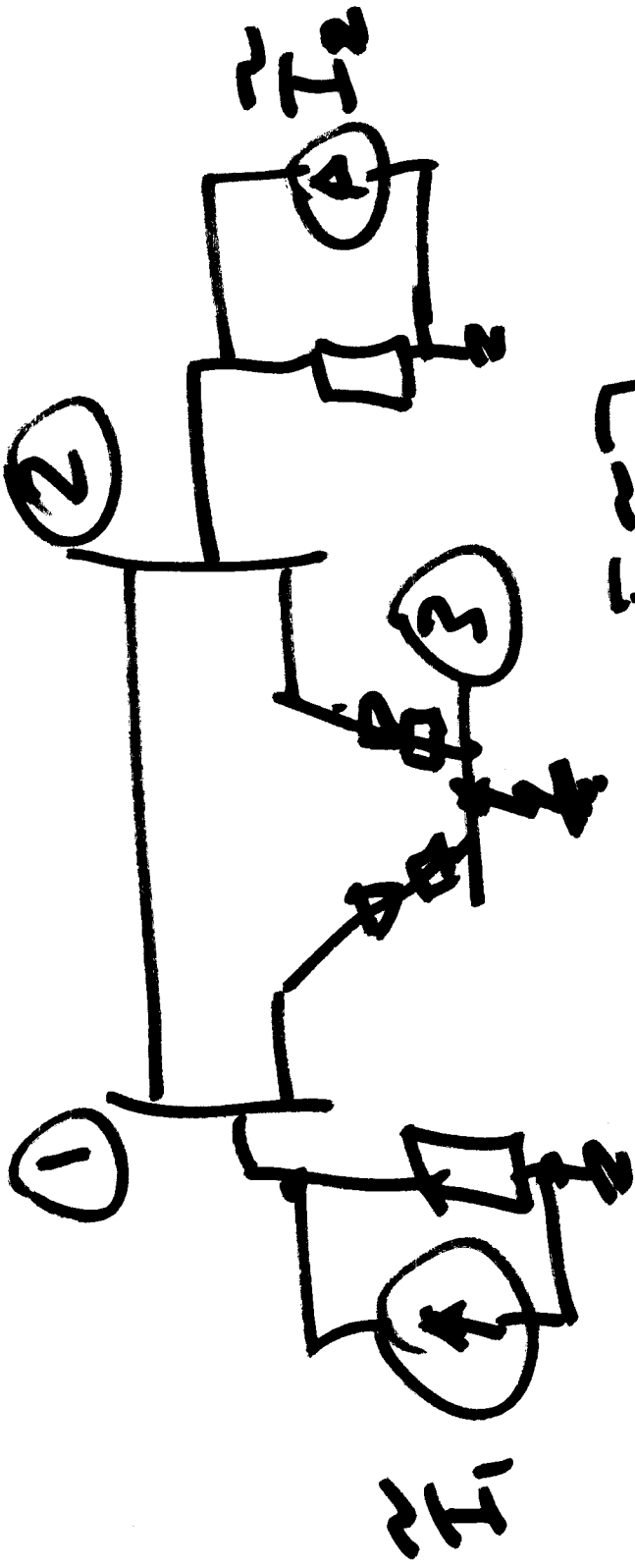

$$\begin{bmatrix} y_{11} & y_{12} & y_{13} \\ y_{21} & y_{22} & y_{23} \\ y_{31} & y_{32} & y_{33} \end{bmatrix} \begin{bmatrix} V_1 \\ V_2 \\ V_3 \end{bmatrix} = \begin{bmatrix} I_1 \\ I_2 \\ 0 \end{bmatrix}$$

↑ unknowns

Short:  
 $Z=0$   
 $I_3 = \infty$

make  $V_3 = 1 \angle 0^\circ$   
 $y_{33}$

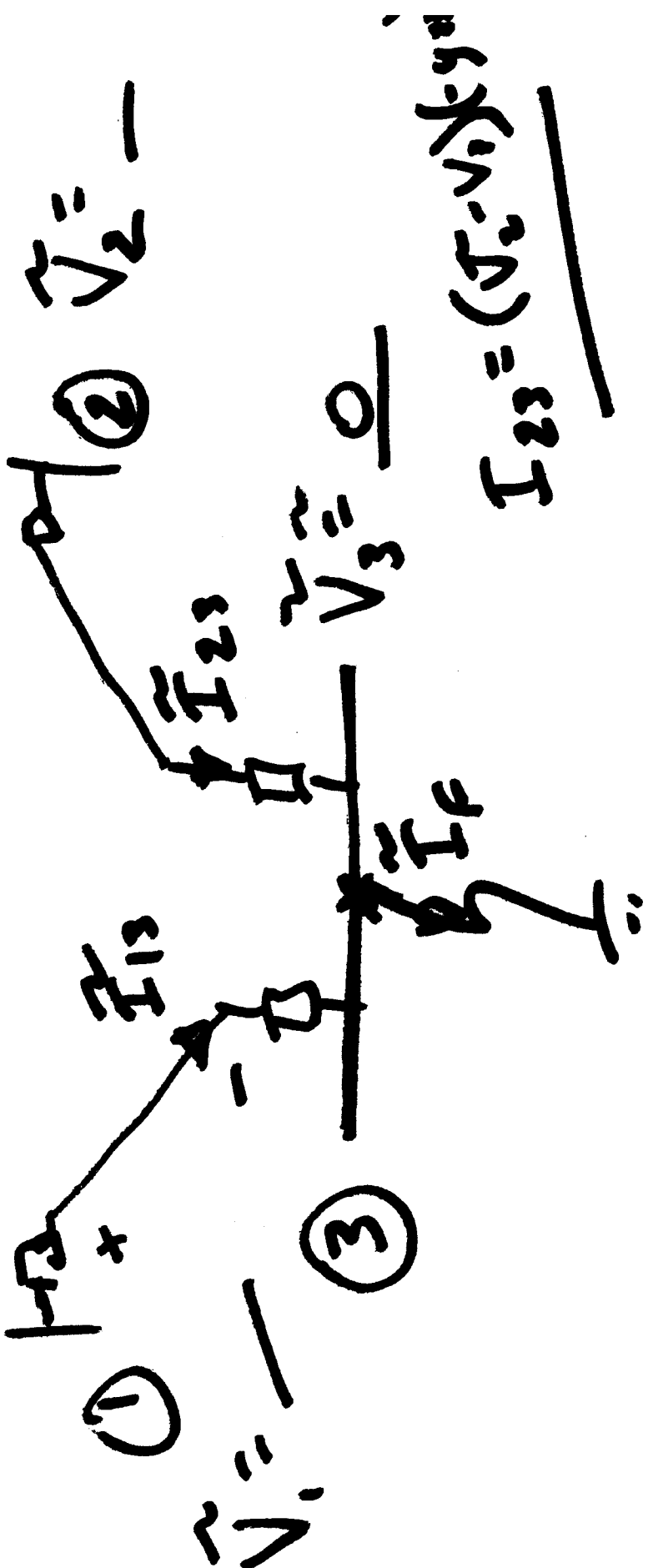

$$\begin{aligned}
 \tilde{I}_{13} &= (\tilde{V}_1 - \tilde{V}_3) (-y_{13}) \\
 &= (\tilde{V}_1 - \tilde{V}_3) \frac{-1/y_{13}}{2-1-3} \\
 \frac{I_{13}}{2-1-3} &= \tilde{I}_{13} + I_{23} = \tilde{V}_3 = \tilde{V}_3 \cdot Y_{31} = \tilde{V}_3 \times 1E15
 \end{aligned}$$

- Bus Configurations

- Fault Current Limiting Reactors.

Bus Trip

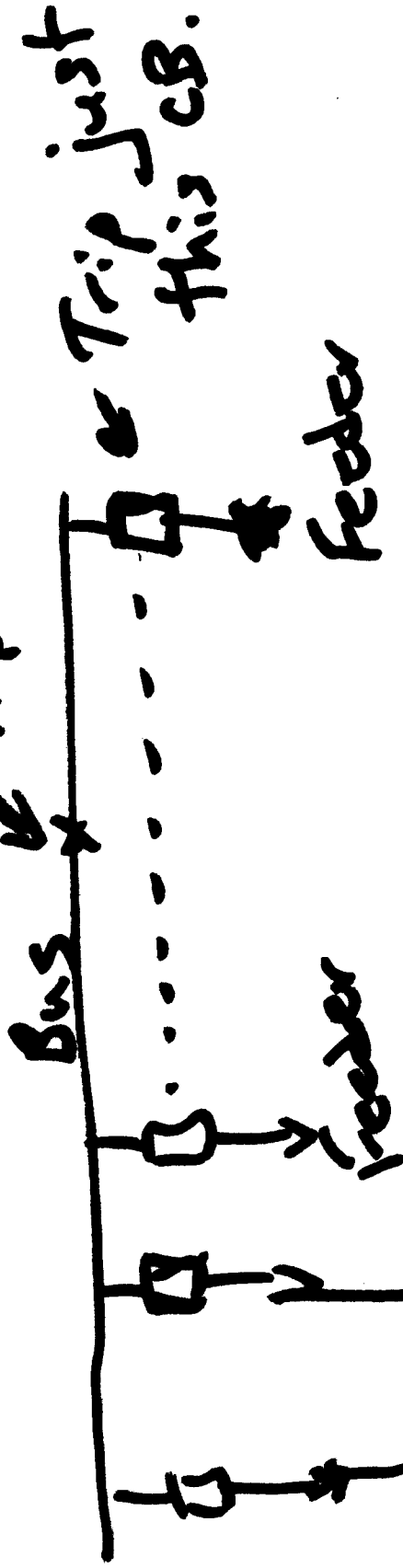

Air-core inductor  
- Current-limiting  
Reactor.

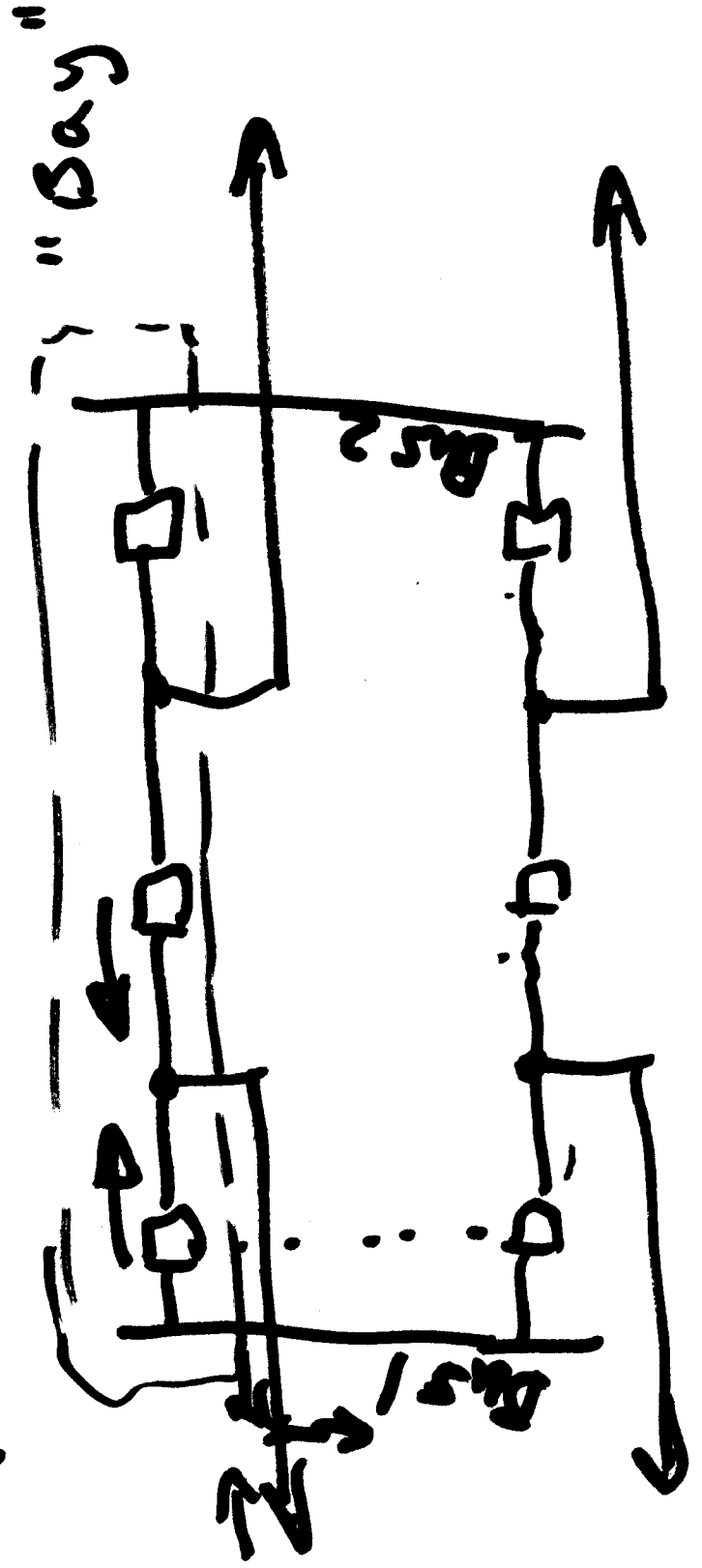
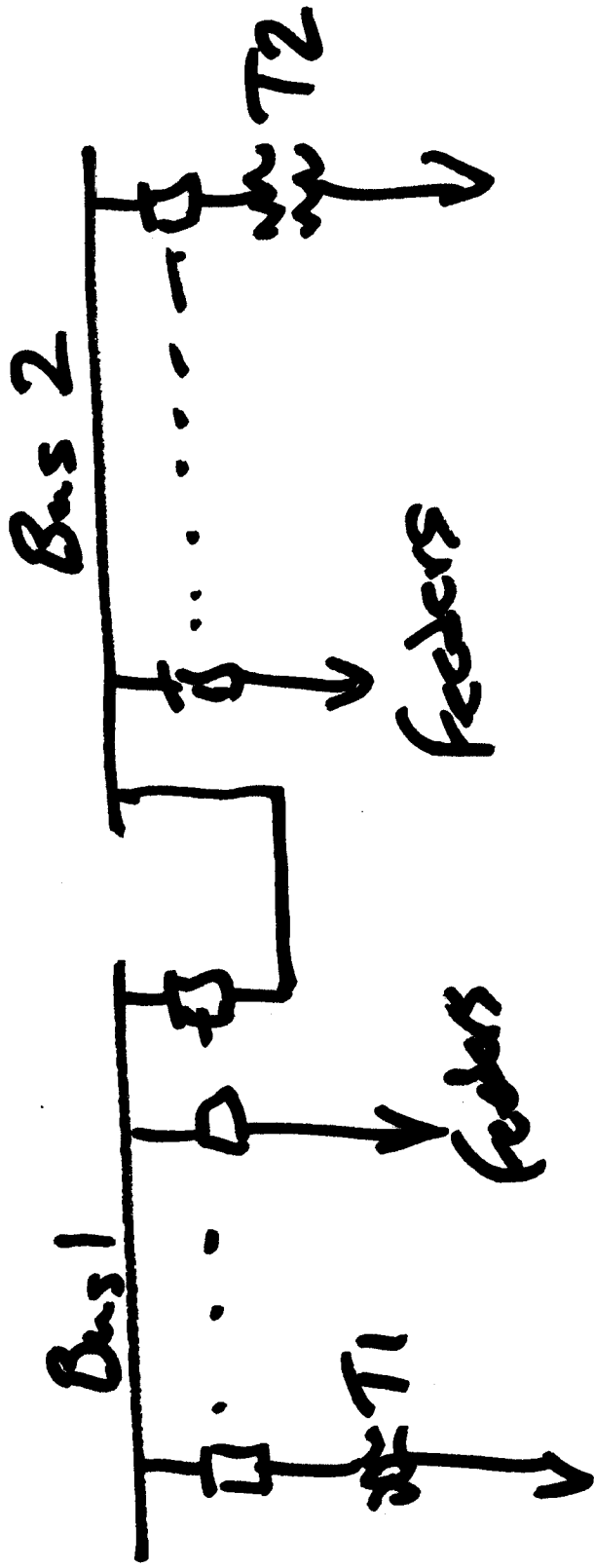

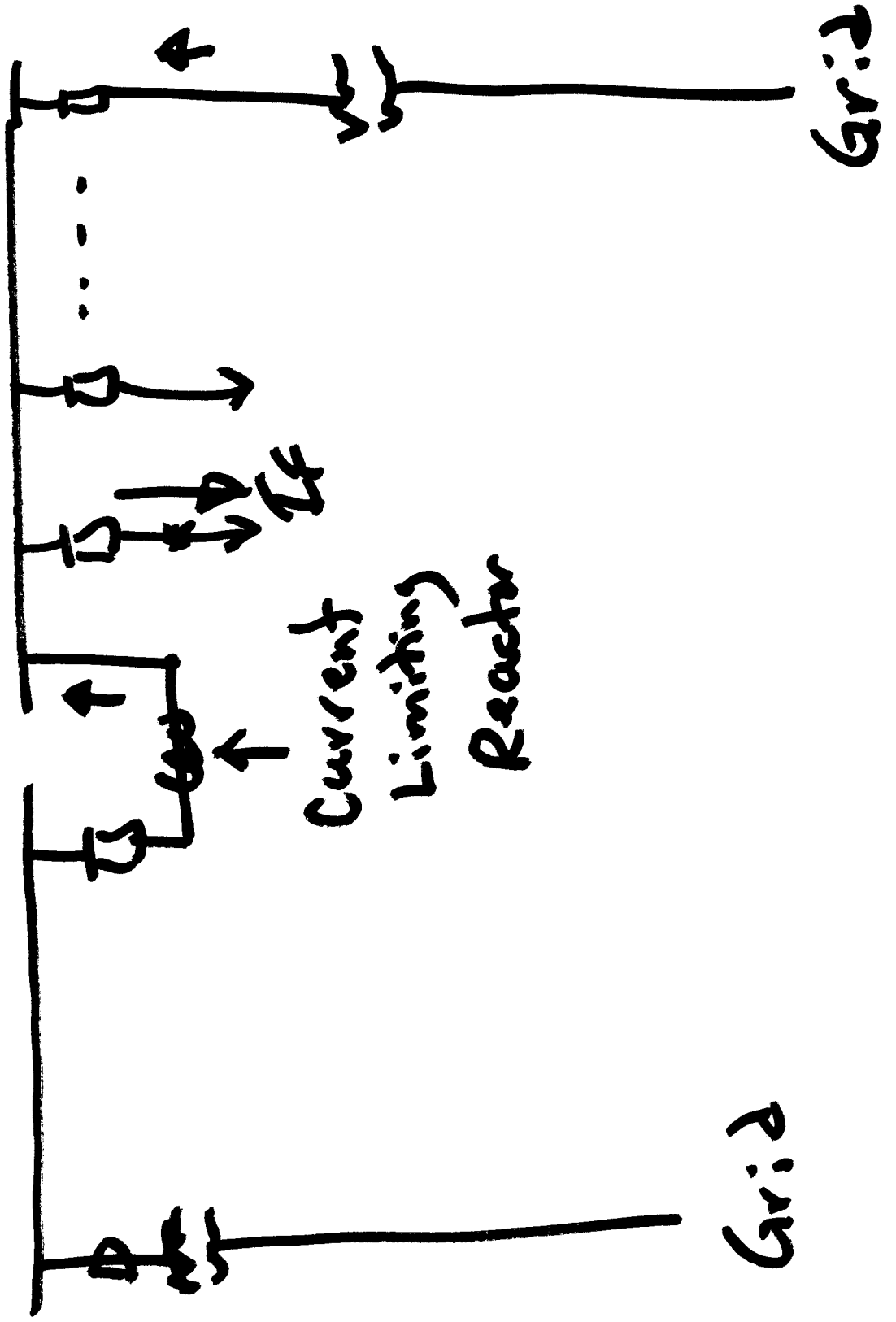

- Planning Studies

- 3 or 5 yr plans

- 10+ yr plans

- Operational

- Emergency Control

real-time

Planning / operations

Arco

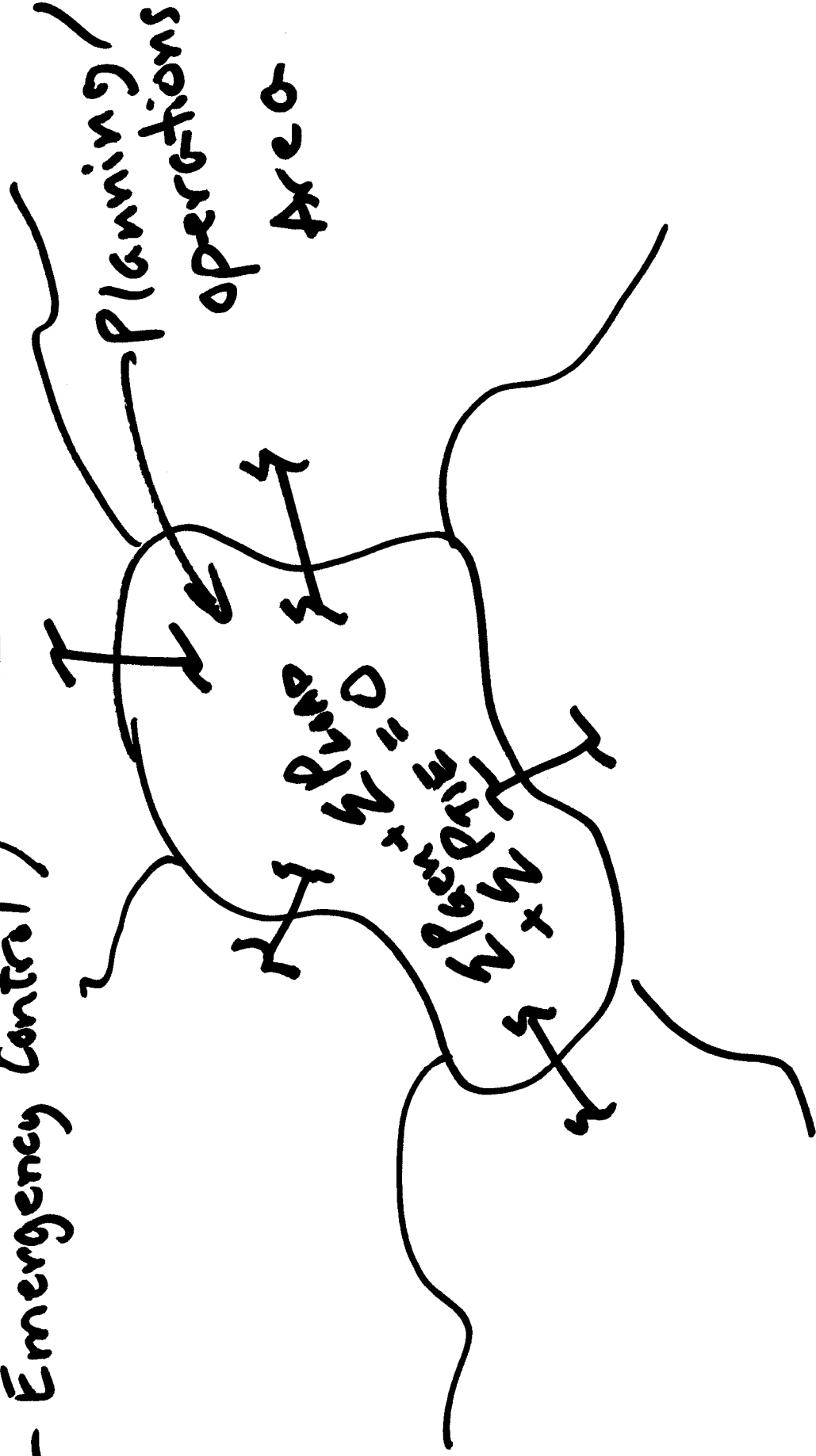

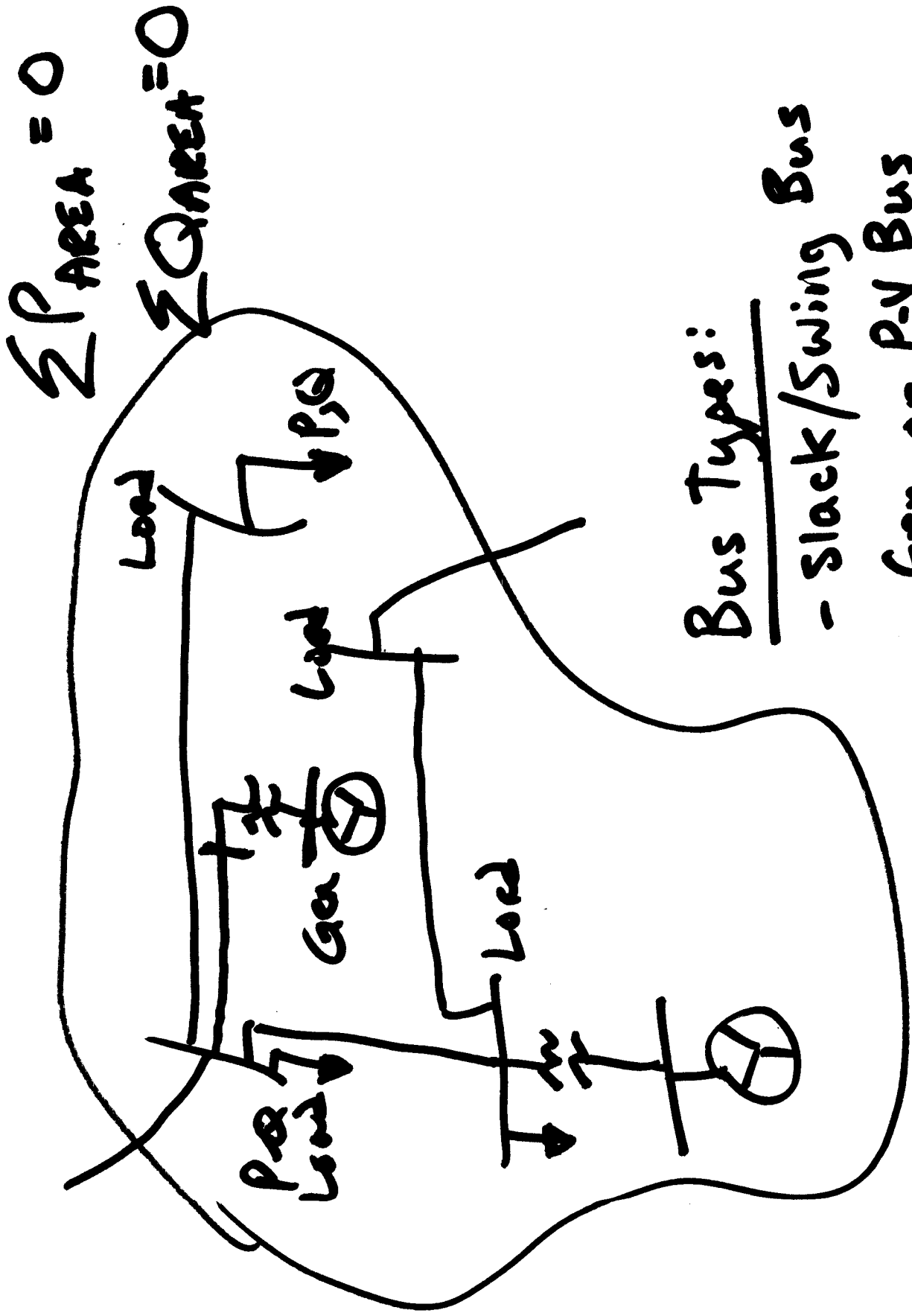

Bus Types:

- Slack/Swing Bus
- Gen or P-V Bus
- Load or P-Q Bus



"Variables":  $P, Q, V, \delta$

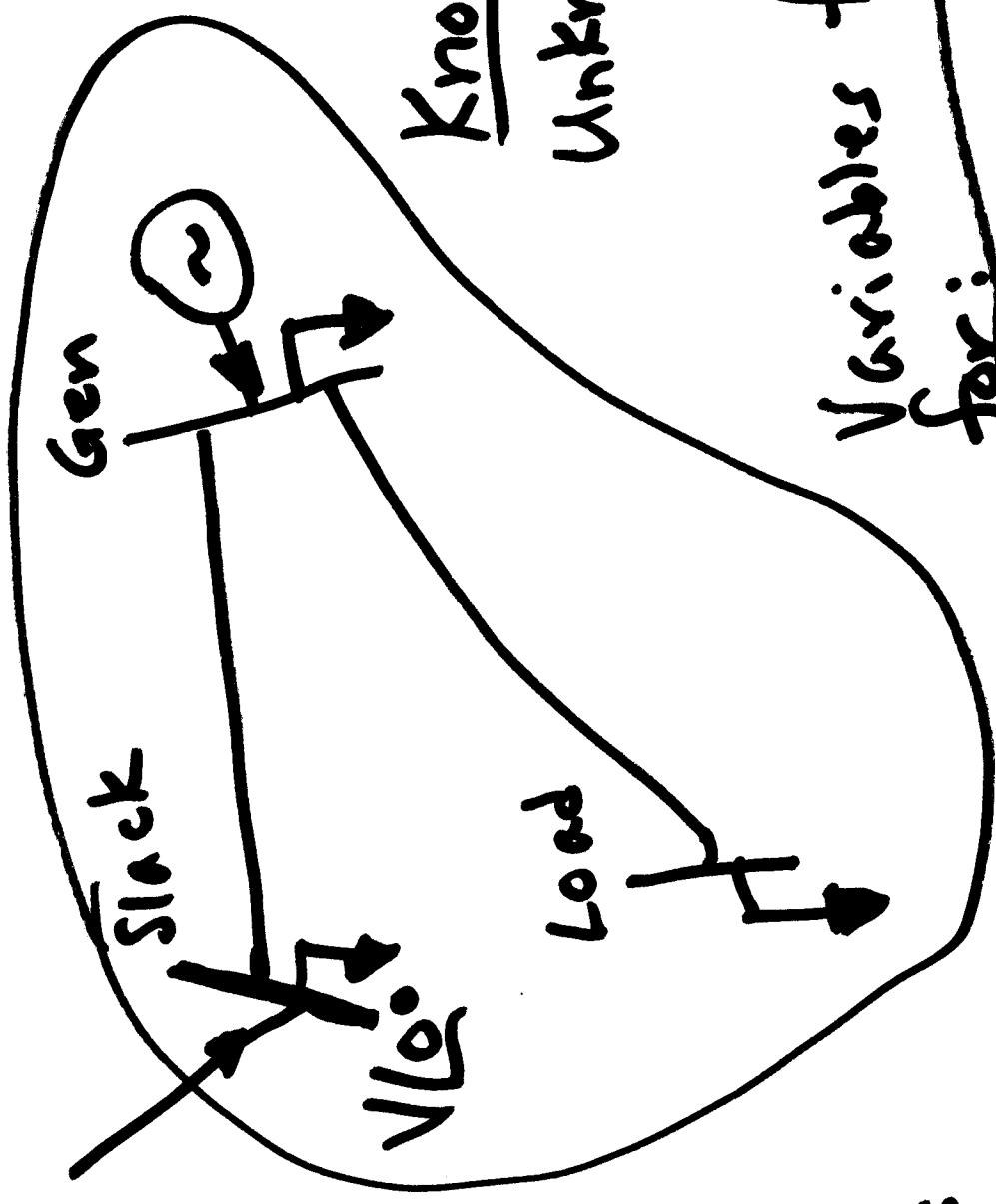

Knowns:  
 $V, \delta$

Unknowns:  
 $P, Q$

Knowns:  $P, V$   
Unknowns:  $\delta, Q$

Knowns:  
 $P, Q$

Unknowns:  
 $V, \delta$

Variables to solve

for:

$2 N_{Load} + N_{Gen}$   
(in NR)

# Look at a typical load:

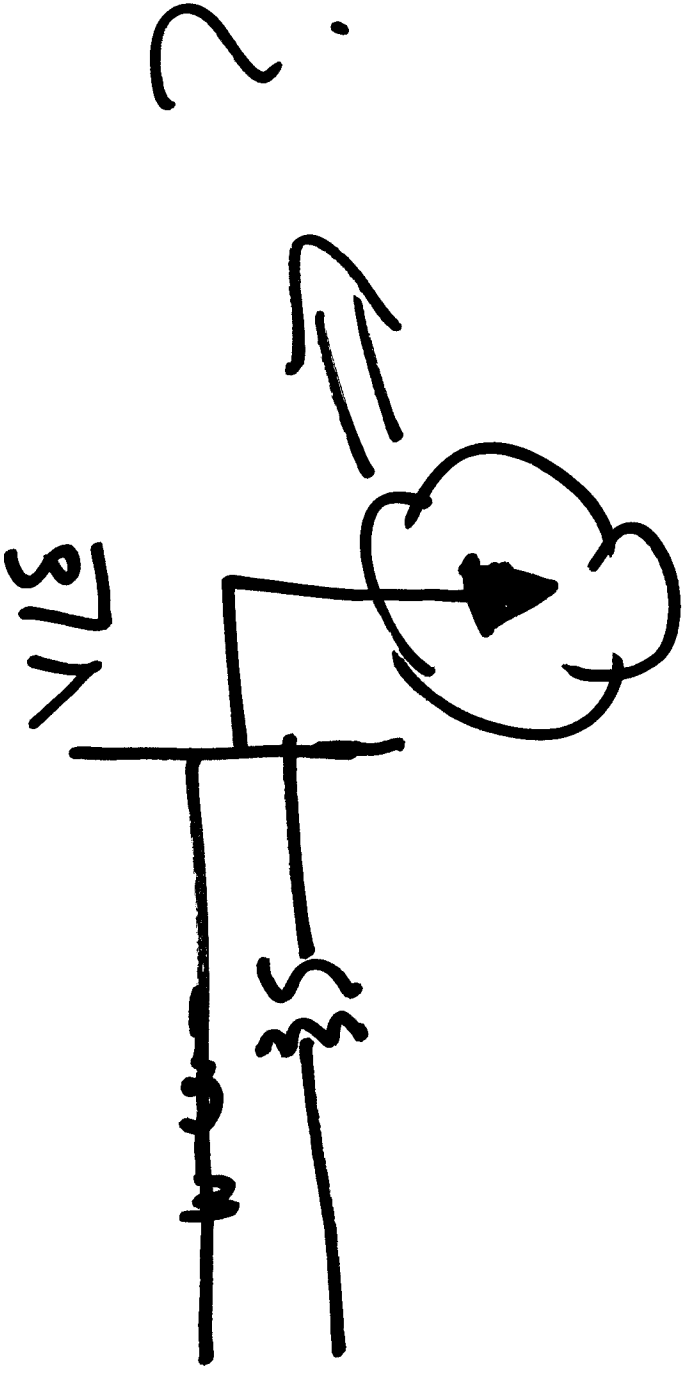

- 1) Scheduled: Const  $P+jQ$  (Const  $\omega$  / Bus  $V$ )
- 2) Const  $Z$  or  $Y$   
 $\frac{1}{Z} = G-jB$   
 $P_{LOAD} = V^2 G$   
 $Q_{LOAD} = V^2 B$
- 3) Const. Current

What is the nature of the aggregate load?

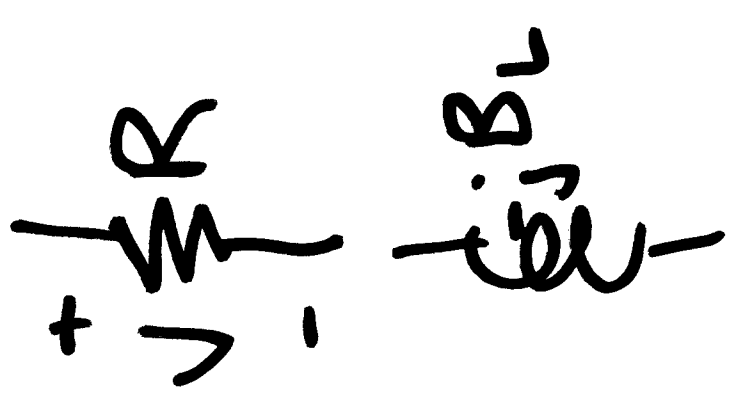
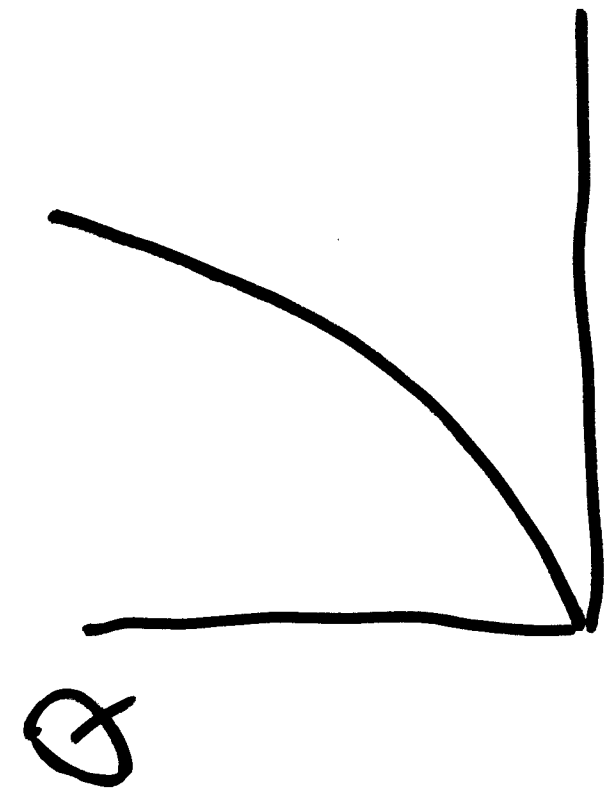
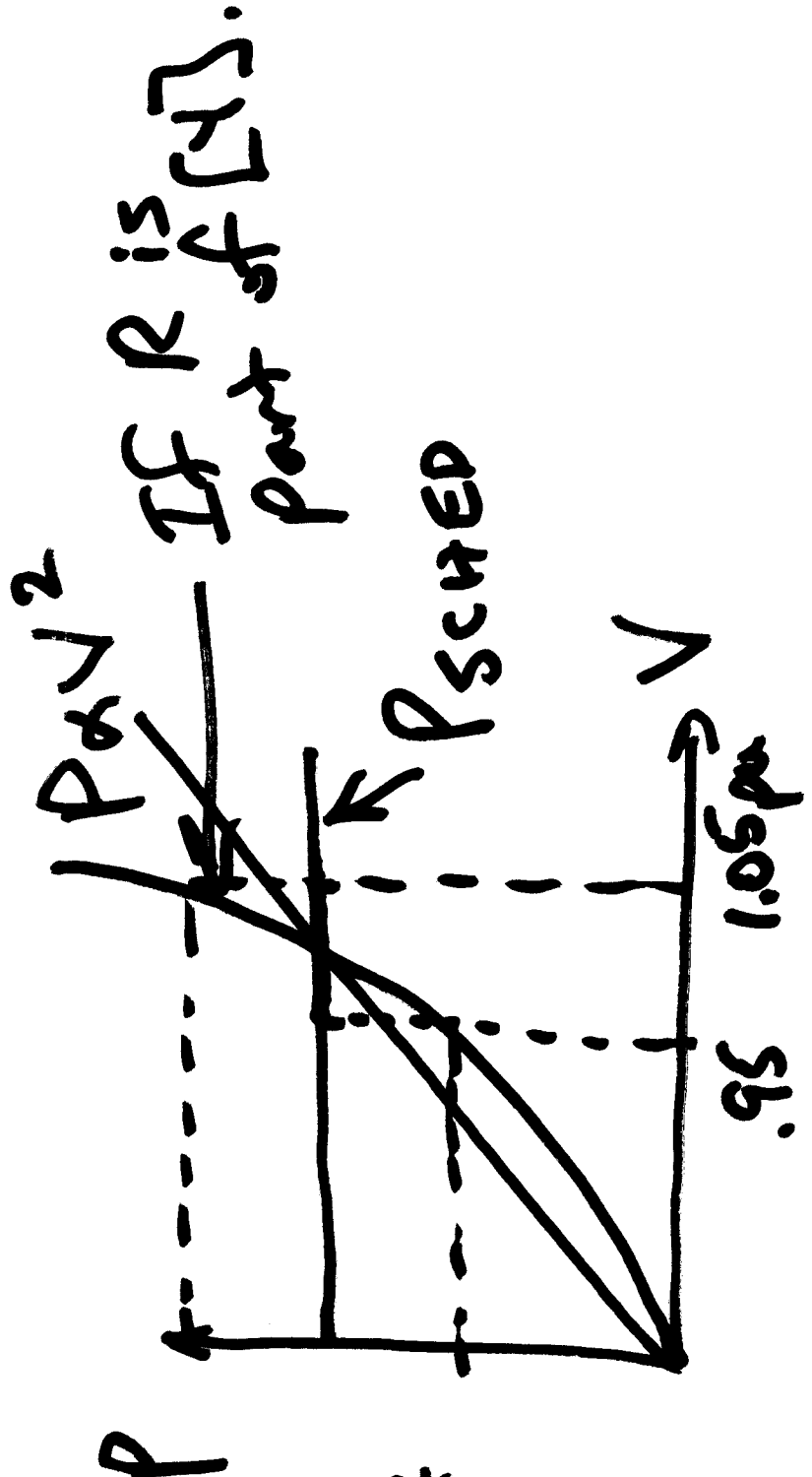

# NEWTON-RAPHSON LOAD FLOW FORMULATION

Dr. Bruce Mork  
EE 5200 - Fall 2019

At a given bus  $i$  in the system, there can exist:

Fixed P and Q injection consisting of:

- ▶ Scheduled generation that injects  $P_{Gi}$  into the bus.
- ▶ A fixed load of  $P_{Li} + jQ_{Li}$  (an injection of  $-P_{Li} - jQ_{Li}$ )

P and Q flowing into bus from the network (all part of  $[Y_{BUS}]$ ):

- ▶ Transmission lines - short, medium, long; single-circuit, double-circuit where mutual coupling is neglected, or double-circuit with mutual coupling effects.
- ▶ Transformers - 2-winding or 3-winding; fixed ratio, LTC, or Phase-Shifting.
- ▶ Shunt reactors:  $Y = 1/(j\omega L) = -jB_{REACT}$
- ▶ Shunt capacitor banks:  $Y = j\omega C = jB_{CAP}$
- ▶ A voltage-dependent load represented as a shunt admittance:  $Y_{LOAD} = G + jB$ .

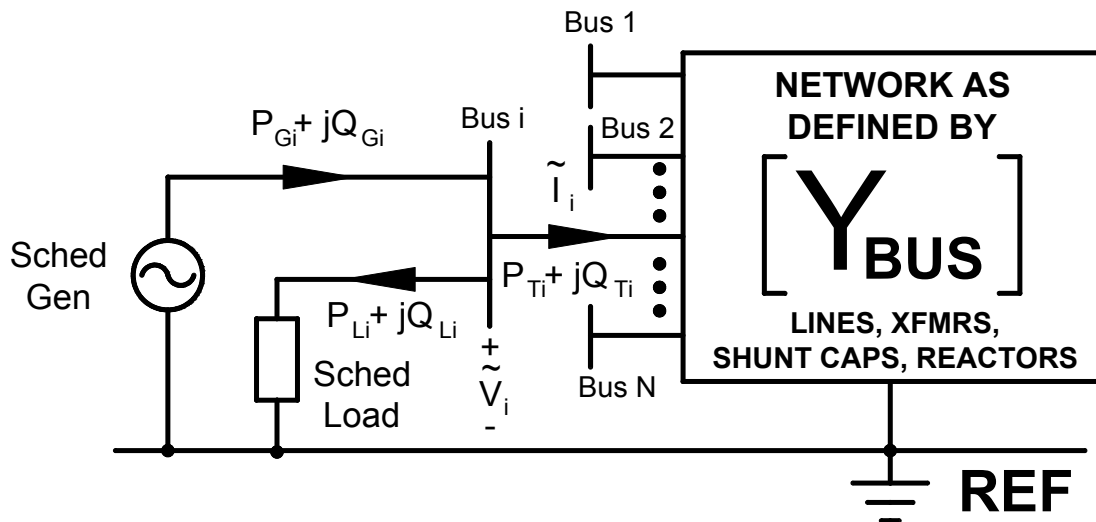

**Important things to note:**

- ▶ The scheduled generation  $P_{Gi}$  is dictated by the system dispatch center via SCADA. The generator's governor is given a "set point" and holds  $P_{Gi}$  constant within a close tolerance. Also, the generator's exciter holds the bus voltage  $V_i$  at a constant magnitude (its angle  $\delta_i$  is not directly controlled and is an unknown).
- ▶ The fixed load  $P_{Li} + jQ_{Li}$  represents the aggregate load supplied to local consumers. In planning studies, this is usually a worst-case projection of what planners think the load will be 5 or 10 or more years into the future.
- ▶  $P_{Ti}$  and  $Q_{Ti}$  are the total P and Q flowing **INTO** the transmission grid defined by  $[Y_{BUS}]$ . This includes the effects of shunt capacitor banks and reactors.

When forming equations, it is extremely important to establish a reference direction for the flow of P, Q, and current. This is clearly labeled on the sketch on the preceding page. Recall that the current  $\tilde{I}_i$  is the net current injected *into* the network at bus i by the generator and load (this is the same injected current that occurs in the equation  $[Y_{BUS}][V] = [I]$ ). Bus voltages are measured with respect to the same reference that  $[Y_{BUS}]$  is referred to.

### Notations:

The voltages and currents we are dealing with are RMS phasor values. In the equations we develop, it is necessary to refer to their magnitudes and angles. For example, the voltage at bus k with respect to reference is:

RMS phasor value:  $\tilde{V}_k$  or  $V_k$  or  $V_k \angle \delta_k$

RMS magnitude:  $|\tilde{V}_k|$  or just  $V_k$       Angle of  $\tilde{V}_k$ :  $\delta_k$

We also need to refer to individual elements of  $[Y_{BUS}]$ . The entry in the i,j position is a complex number  $\bar{y}_{ij}$  with a magnitude of  $y_{ij}$  and an angle of  $\theta_{ij}$

### The Setup:

At each bus, there are just three components to the P and Q being injected. If we follow the development of Heydt's book, we will consider the summation of P and Q *into* a given bus i (refer to the figure on the previous page and be sure to get the signs right). When the system is in equilibrium the total P and total Q flowing into the bus will be zero.

$$\sum P_{INTO\ BUS\ i} = P_{Gi} - P_{Li} - P_{Ti} = 0$$

$$\sum Q_{INTO\ BUS\ i} = Q_{Gi} - Q_{Li} - Q_{Ti} = 0$$

Observe that  $P_{Ti}$  and  $Q_{Ti}$  are functions of the bus voltages, while  $P_{Li}$  and  $Q_{Li}$  and  $P_{Gi}$  are constants (scheduled).  $Q_{Gi}$  is a "slack" variable (more on it later). Note that these two equations together make up the nonlinear function  $F(\delta, V) = 0$  which will be solved with Newton-Raphson iteration. (i.e. initial guesses for the unknown V's and  $\delta$ 's are made and an iteration is performed that drives the V's and  $\delta$ 's toward values that make  $F(\delta, V) = 0$ ). When the iteration has converged, we know all of the bus voltages in the system and then can calculate all P and Q flows through transmission lines, transformers, and the slack bus.

In order to calculate  $P_{Ti}$  and  $Q_{Ti}$  we must first know the value of  $\tilde{I}_i$ , which can be found by multiplying row  $i$  of  $[Y_{BUS}]$  times the bus voltage vector. In the form of a summation, it is:

$$\tilde{I}_i = \sum_{j=1}^N \bar{y}_{ij} \tilde{V}_j$$

The complex power flowing into the network at this point is thus

$$\bar{S}_{Ti} = P_{Ti} + jQ_{Ti} = \tilde{V}_i \tilde{I}_i^* = \tilde{V}_i \left[ \sum_{j=1}^N \bar{y}_{ij} \tilde{V}_j \right]^*$$

Resolving it into its real and imaginary components,

$$P_{Ti} = V_i \sum_{j=1}^N y_{ij} V_j \cos(\delta_i - \delta_j - \theta_{ij})$$

$$Q_{Ti} = V_i \sum_{j=1}^N y_{ij} V_j \sin(\delta_i - \delta_j - \theta_{ij})$$

Thus, the total P and Q flowing *into* bus  $i$  for a converged solution is

$$F_{P,i}(\delta, V) = P_{IN,i} = \sum P_{INTO\,BUS\,i} = P_{Gi} - P_{Li} - V_i \sum_{j=1}^N y_{ij} V_j \cos(\delta_i - \delta_j - \theta_{ij}) = 0$$

$$F_{Q,i}(\delta, V) = Q_{IN,i} = \sum Q_{INTO\,BUS\,i} = Q_{Gi} - Q_{Li} - V_i \sum_{j=1}^N y_{ij} V_j \sin(\delta_i - \delta_j - \theta_{ij}) = 0$$

Heydt lumps load and generation together:  $P_i = P_{Gi} - P_{Li}$  and  $Q_i = Q_{Gi} - Q_{Li}$  and refers to them as "specified active and reactive powers." The "mismatches"  $\Delta P_i$  and  $\Delta Q_i$  are defined as the difference between the specified P and Q (flowing into the bus from the load and generator) and the P and Q flowing out of the bus and into the network. At equilibrium (when loadflow has converged) the mismatches are, within a tolerance of  $\epsilon$ , equal to zero. However, during the iteration, the mismatches are nonzero and are a function of the present values of  $\delta$  and  $V$ . At iteration step  $m$ ,

$$\begin{bmatrix} \Delta P_i^m \\ \Delta Q_i^m \end{bmatrix} = \begin{bmatrix} \left[ P_i - P_{Ti}(\delta, V) \right] - \left[ P_i - P_{Ti}(\delta^m, V^m) \right] \\ \left[ Q_i - Q_{Ti}(\delta, V) \right] - \left[ Q_i - Q_{Ti}(\delta^m, V^m) \right] \end{bmatrix} = \begin{bmatrix} -P_i + P_{Ti}(\delta^m, V^m) \\ -Q_i + Q_{Ti}(\delta^m, V^m) \end{bmatrix}$$

The complete expressions for the mismatches at iteration step  $m$  are thus given as:

$$\Delta P_i^m = -P_i + V_i^m \sum_{j=1}^N y_{ij} V_j^m \cos(\delta_i^m - \delta_j^m - \theta_{ij})$$

$$\Delta Q_i^m = -Q_i + V_i^m \sum_{j=1}^N y_{ij} V_j^m \sin(\delta_i^m - \delta_j^m - \theta_{ij})$$

Note that Heydt has a sign error in the way that he defines  $\Delta P$  and  $\Delta Q$  (see p.149), but then recovers from it by tagging a minus sign on  $[J]$  (see p.150). The complete formulation for the loadflow is thus in the form

$$[J] \begin{bmatrix} \Delta \delta \\ \Delta V \end{bmatrix} = \begin{bmatrix} \Delta P \\ \Delta Q \end{bmatrix}$$

$\Delta P$  is the column vector of P mismatches at all buses except the slack bus.  $\Delta Q$  is the column vector of Q mismatches at all load buses (Q is a slack variable at all generator buses and at the slack bus and so these buses are not included).  $[J]$  is the Jacobian matrix containing the partial derivatives of the expressions for P and Q flowing into each bus. These partial derivatives fall into 4 categories and  $[J]$  is often partitioned into 4 submatrices described as follows:

$$\begin{bmatrix} J1 & J2 \\ J3 & J4 \end{bmatrix} \begin{bmatrix} \Delta \delta \\ \Delta V \end{bmatrix} = \begin{bmatrix} \Delta P \\ \Delta Q \end{bmatrix}$$

or

$$\begin{bmatrix} \frac{\partial P_{IN}}{\partial \delta} & \frac{\partial P_{IN}}{\partial V} \\ \frac{\partial Q_{IN}}{\partial \delta} & \frac{\partial Q_{IN}}{\partial V} \end{bmatrix} \begin{bmatrix} \Delta \delta \\ \Delta V \end{bmatrix} = \begin{bmatrix} \Delta P \\ \Delta Q \end{bmatrix}$$

The partials can be obtained from the equations for  $P_{IN}$  and  $Q_{IN}$ . They are listed in equations (4.38) through (4.45) in your text.

For the main diagonal terms of J1 note that when  $j = i$ ,  $\delta_i - \delta_j = 0$  and the partial is 0.

$$J1_{ii} = \frac{\partial P_{IN,i}}{\partial \delta_i} = V_i \sum_{\substack{j=1 \\ \neq i}}^N y_{ij} V_j \sin(\delta_i - \delta_j - \theta_{ij})$$

For the off-diagonal terms of J1, only one of the terms of the summation has a non-zero partial derivative:

$$J1_{ik} = \frac{\partial P_{IN,i}}{\partial \delta_k} = -V_i V_k y_{ik} \sin(\delta_i - \delta_k - \theta_{ik}) \quad i \neq k$$

For the main diagonal terms of J2,  $j = i$  so  $V_i V_j = V_i^2$  which leads to

$$J2_{ii} = \frac{\partial P_{IN,i}}{\partial V_i} = - \sum_{\substack{j=1 \\ \neq i}}^N y_{ij} V_j \cos(\delta_i - \delta_j - \theta_{ij}) - 2V_i y_{ii} \cos(-\theta_{ii})$$

For off-diagonal terms of J2,

$$J2_{ik} = \frac{\partial P_{IN,i}}{\partial V_k} = -V_i y_{ik} \cos(\delta_i - \delta_k - \theta_{ik}) \quad i \neq k$$

For main diagonal terms of J3 (note sign error in equation 4.42):

$$J3_{ii} = \frac{\partial Q_{IN,i}}{\partial \delta_i} = -V_i \sum_{\substack{j=1 \\ \neq i}}^N y_{ij} V_j \cos(\delta_i - \delta_j - \theta_{ij})$$

For off-diagonal terms of J3:

$$J3_{ik} = \frac{\partial Q_{IN,i}}{\partial \delta_k} = V_i V_k y_{ik} \cos(\delta_i - \delta_k - \theta_{ik}) \quad i \neq k$$

For main diagonal terms of J4:

$$J4_{ii} = \frac{\partial Q_{IN,i}}{\partial V_i} = - \sum_{\substack{j=1 \\ \neq i}}^N y_{ij} V_j \sin(\delta_i - \delta_j - \theta_{ij}) - 2V_i y_{ii} \sin(-\theta_{ii})$$

Finally, for off-diagonal terms of J4:

$$J4_{ik} = \frac{\partial Q_{IN,i}}{\partial V_k} = -V_i y_{ik} \sin(\delta_i - \delta_k - \theta_{ik}) \quad i \neq k$$

All terms in the Jacobian and in the mismatch vector are evaluated using "present" values of V and  $\delta$ . The column vector for  $\Delta\delta \Delta V$  is then solved. Typically this is done using sparse matrix data structures and some type of in situ LU factorization. The values of  $\delta$  and V used in the present iteration are then updated:

$$\begin{bmatrix} \delta \\ V \end{bmatrix}^{m+1} = \begin{bmatrix} \delta \\ V \end{bmatrix}^m + \begin{bmatrix} \Delta\delta \\ \Delta V \end{bmatrix}^m$$

Convergence is usually determined by monitoring the mismatch vector. The norm of the mismatch vector could be used as a convergence measure but usually is not. Testing for  $|\Delta P_i| \leq \epsilon$  at all PQ and PV busses, and testing for  $|\Delta Q_i| \leq \epsilon$  at all PQ buses is done. Choosing  $\epsilon = 0.001$  per unit is common. Typically, the Q mismatches are greater than P mismatches so convergence often depends on  $\Delta Q$ . If the precision of the loadflow study is not of primary concern, the convergence tolerance for Q is sometimes relaxed to  $10\epsilon$  or else the condition is modified to be  $|\Delta Q_i^2| \leq \epsilon$ .