

Topics for Today:

- Announcements
 - Software: online students - apply for ATP/ATPDraw license, verify licensing when you receive it by e-mail, and we will mail you the install CD.
 - ASPEN software - run off of MTU server via internet, see e-mail instructions.
 - Office: EERC 614. Learning Center Hrs: 4-6pm Wed and Fri
 - Recommended problems & all solutions: Ch. 13 solns now posted.

Ongoing topics...

- Chapter 13 - Power system operation, AGC, economic dispatch
 - Constrained optimization methods - LaGrange multipliers
 - Optimal Dispatch, Generator Scheduling
 - Economics
 - Other constraints - environmental, contractual, availability
 - System load characteristics
 - Application to lossless system
 - System including losses - use [B] loss coefficient matrix

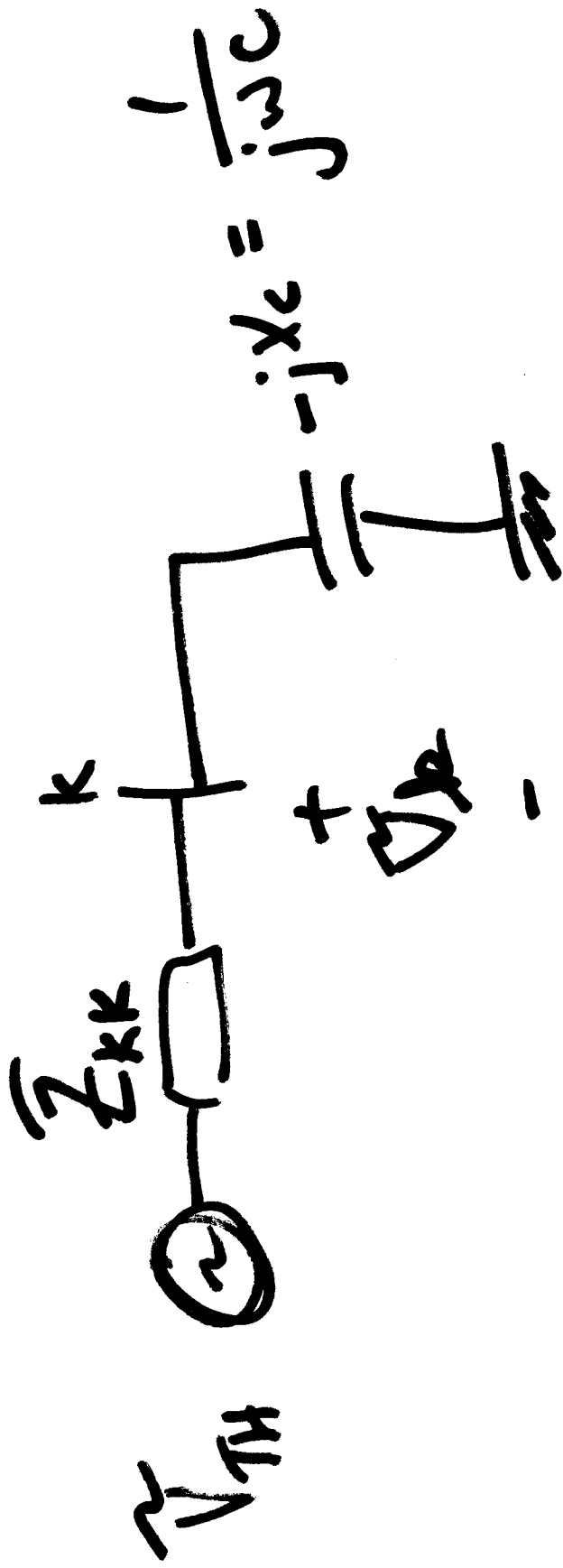

$$V_k = \left| \frac{V_{TH} \cdot (-jX_c)}{Z_{kk} + (-jX_c)} \right| = 1.03$$

↑

0.68

Loadflow

- "Flat" Start vs. "hot" Start

Key: Must give initial values to V & δ .

Slack Bus: V is fixed; $\delta = 0$.

PV Bus: V is " "; $\delta = \text{---}$?

PQ Bus: $V = \text{---}$? ; $\delta = \text{---}$?

At PV Bus: $\delta = 0$ (Flat start)

PQ " : $V = 1.0 \text{ p.u.}$

PQ " : $\delta = 0$



2

Hot Start: Use δ & ν values

from a similar converged case.

Is convergence guaranteed?

No! Nonlinear system of eqns. NR uses first-order (i.e. LINEAR) approximation at each iteration to move toward the soln.

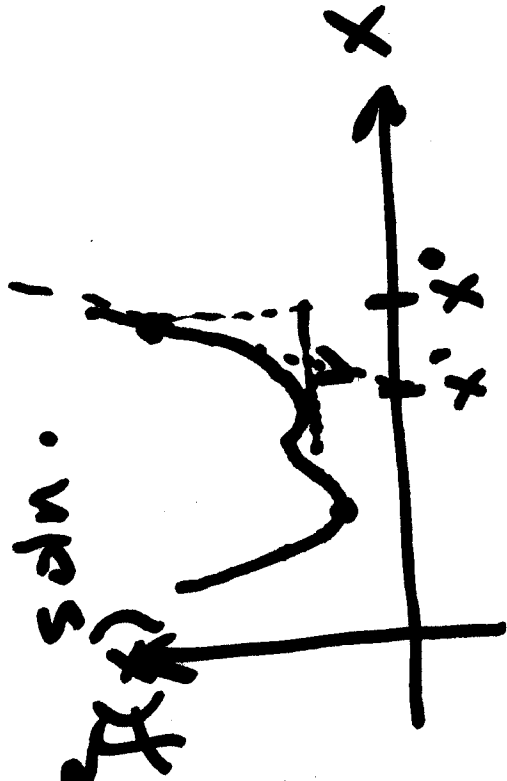

EE 5240

3

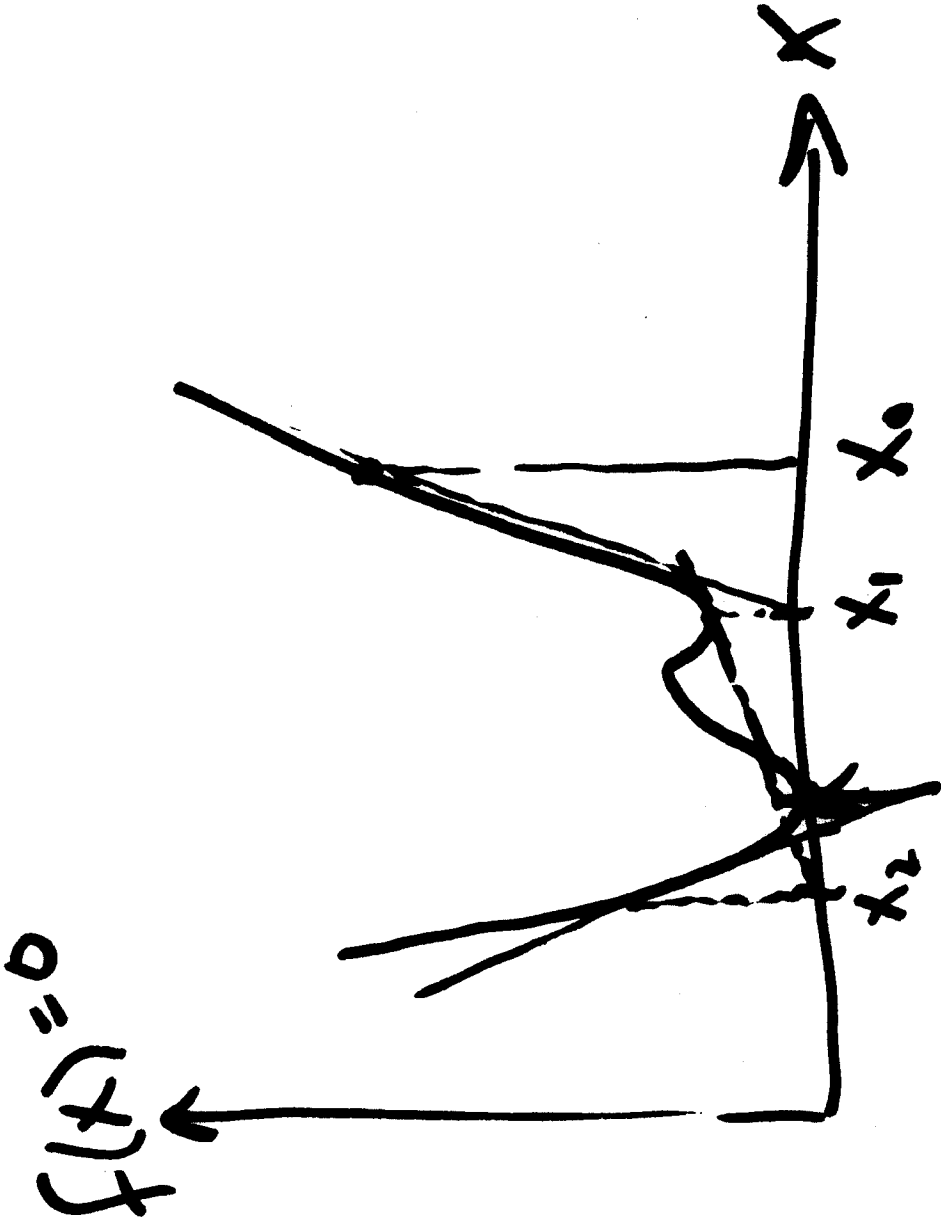

Soln

Risk: - May converge to local solns
not global soln.

- May "blow up" F.P. overflow.

Automatic Generation Control (AGC)

For equilibrium (constant speed) generator operation, or constant system frequency,

$$P_{G_{TOT}} = P_{L_{TOT}} + P_{LOSS_{TOT}}$$

If tie lines are included,

$$P_{G_{TOT}} = P_{L_{TOT}} + P_{TIE_{TOT}} + P_{LOSS_{TOT}}$$

The portion of the overall power system under a given utility's control is a "control area".

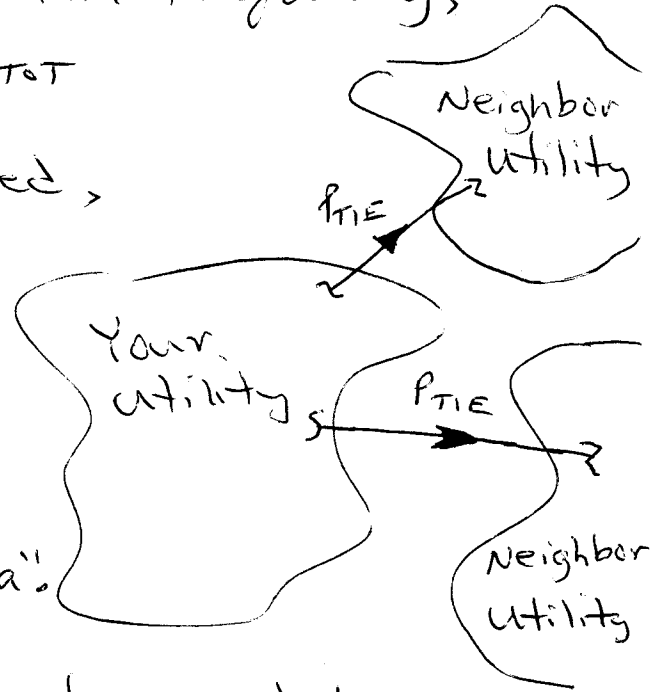

A group of utilities under collective control is called

- A power pool - If tie lines not controlled.
- An interconnected system - If tie line flow is controlled.

ACE (Area Control Error) is a measure of the difference between scheduled and actual tie-line interchange. ACE ~~is~~ is "biased" to include effect of actual system freq vs. f_{synch} .

Consider operation of an individual turbine-generator set. For a given throttle valve setting, ~~the steam flow and resulting torque depend on~~ steam flow and resulting torque depend on $P_{mech} = T\omega_{mech} = P_{elec}$.

From Gross, 2nd Ed.

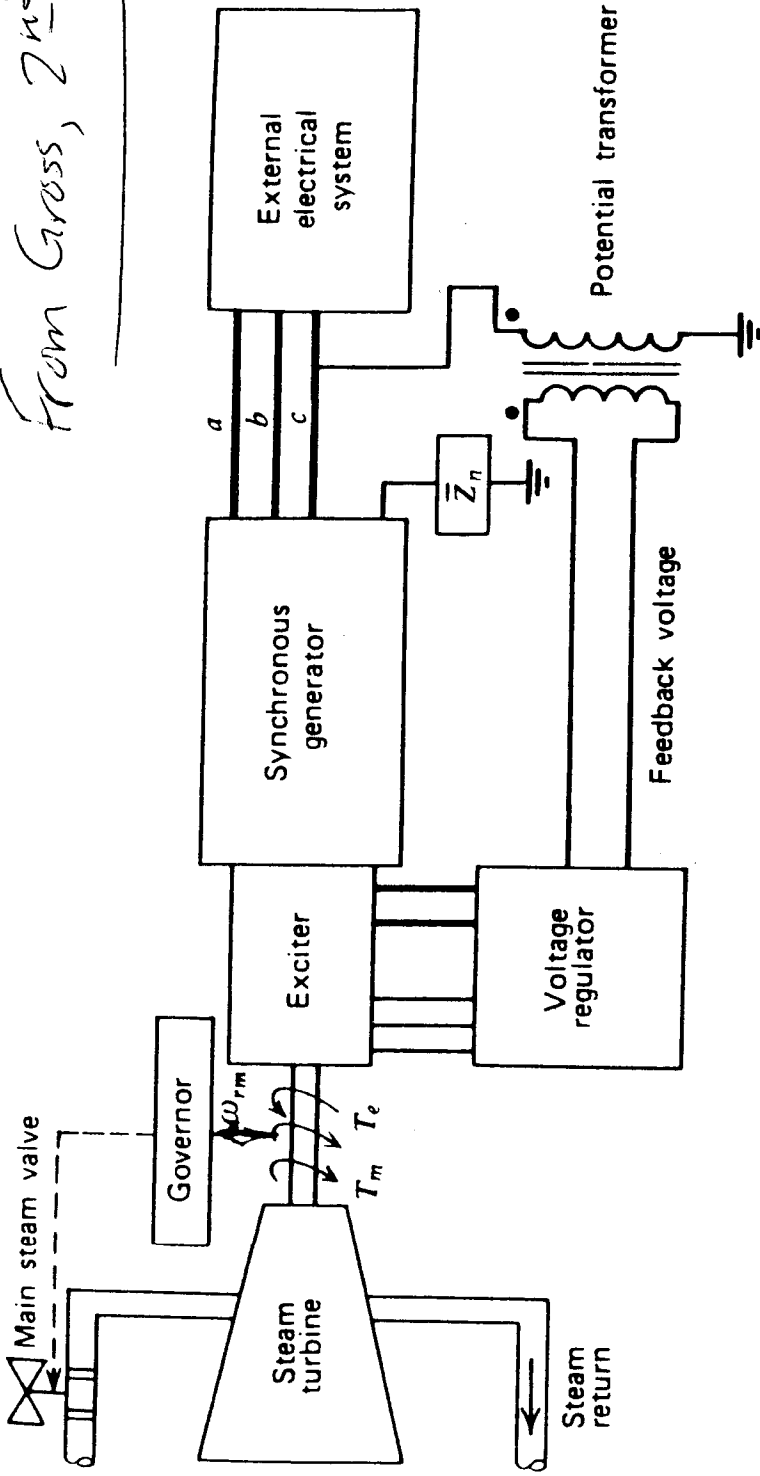

Figure 6.10. Turbine-generator-exciter system

1a

Exciters

- Old - Aux gen connected on shaft
 - New - Static w/ slip rings
 - Brushless - inverted gen - field in stator
 - arm in rotor, rectified for field.
- ↑ No slip rings or brushes req'd.

General Idea:

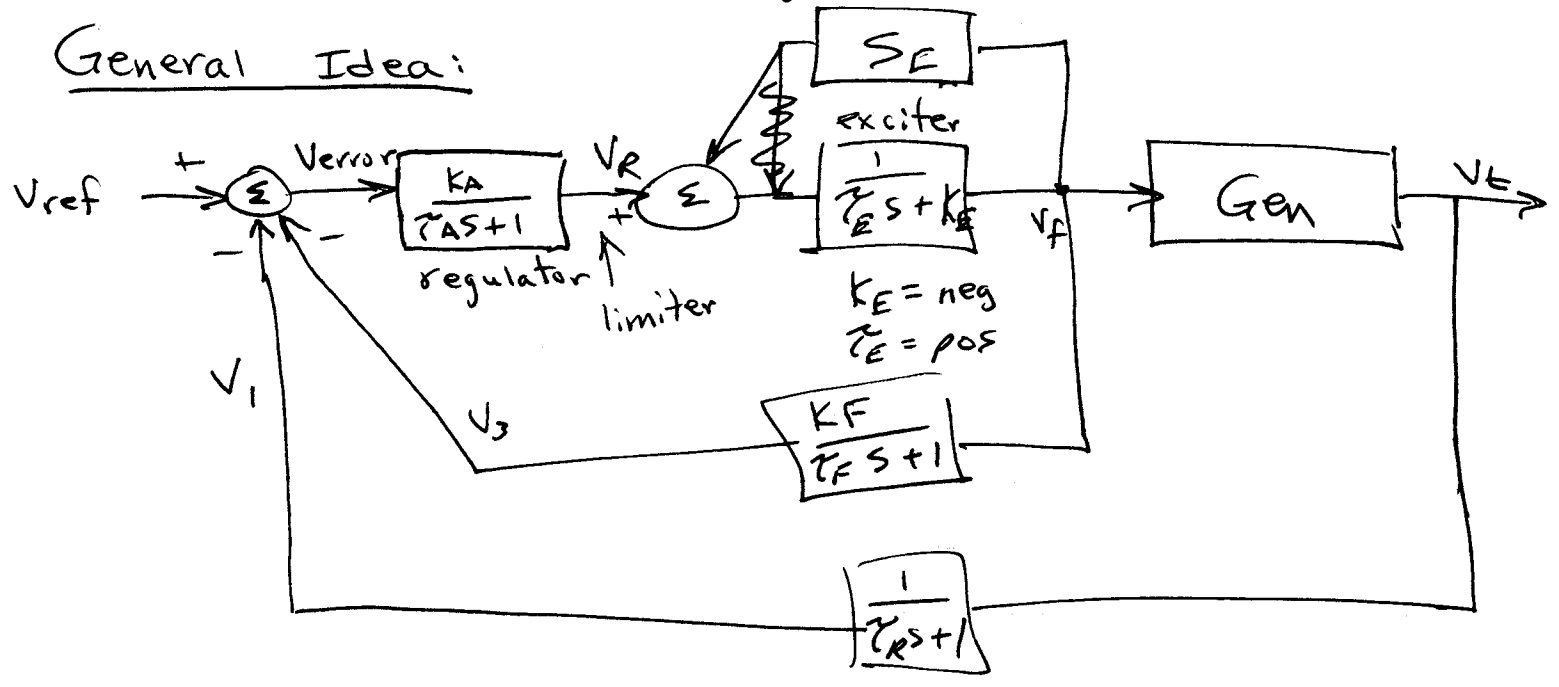

SE used to provide stability. (Stabilizing Compensator).

Terms:

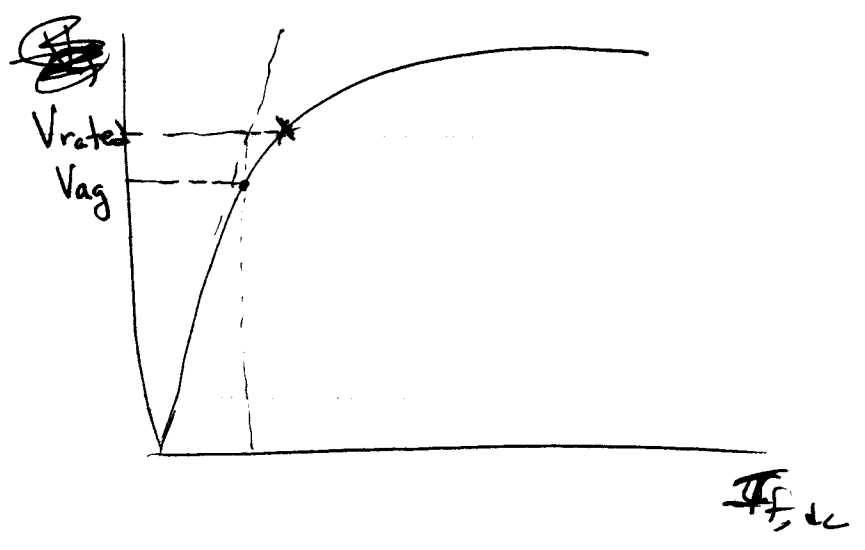

Any change in P_e will affect the speed and torque of the so-called prime mover. (i.e. constant torque cannot be assumed).

First order responses are assumed for the turbine and ~~generator~~ governor.

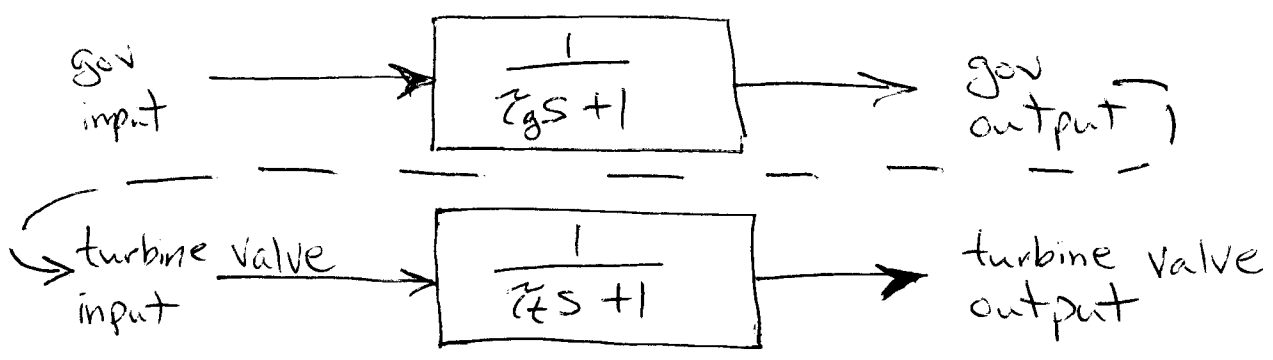

Turbine/Gov as a whole:

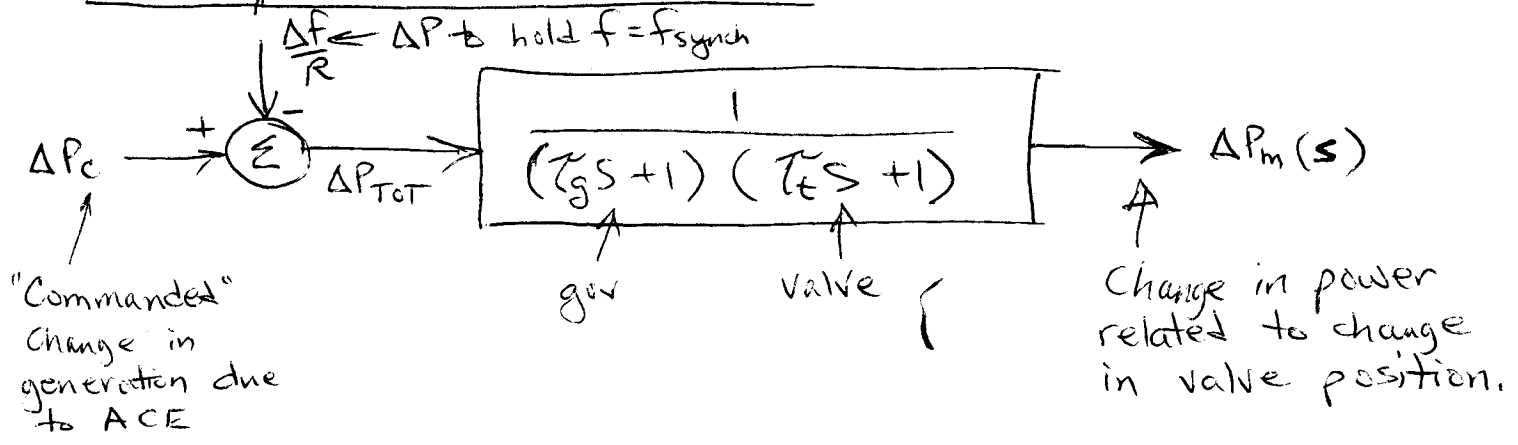

The effect of these 2 controllers in steady state operating point results in a "droop characteristic"

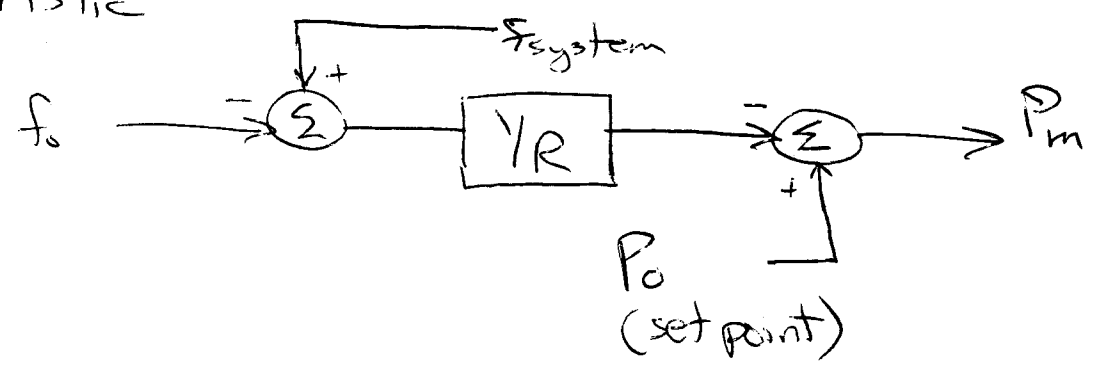

Any change in P_e will affect the speed and torque of the so-called prime mover. (i.e. constant torque & speed cannot be assumed.)

Must first get a feel for the steady-state operating points. We shall see that frequency is a useful feedback signal for controlling P_m .

In steady state:

$$\Delta P_m = \Delta P_{ref} - \frac{1}{R} \Delta f$$

$\circ = \text{neglect for s-s}$ \uparrow Also called ΔP_e

$$\Delta f = f - f_0$$

$$\Delta P_m = P_0 - P_m$$

$P_0 = \text{set point} = P_{ref} = P_{set}$
 $P_m = \text{actual } P_{TURBINE}$
 $f = \text{actual freq}$
 $f_0 = \text{set point freq} \approx 60 \text{ Hz}$

$$R = - \frac{\Delta f}{\Delta P_m} \quad (\text{always pos})$$

Both f & P are in per unit on machine's base.
 $\therefore R$ is also in per unit.

Typically must convert R to system base.
 Δf part of R does not need to be converted.
 Only ΔP_m term is converted.

$$R_{SYS} = \frac{\Delta f}{\Delta P_m \left(\frac{P_{BASE, MACH}}{P_{BASE, SYS}} \right)} \Rightarrow R_{ON SYS} = R_{MACH} \left(\frac{S_{BASE SYS}}{S_{BASE MACH}} \right)$$

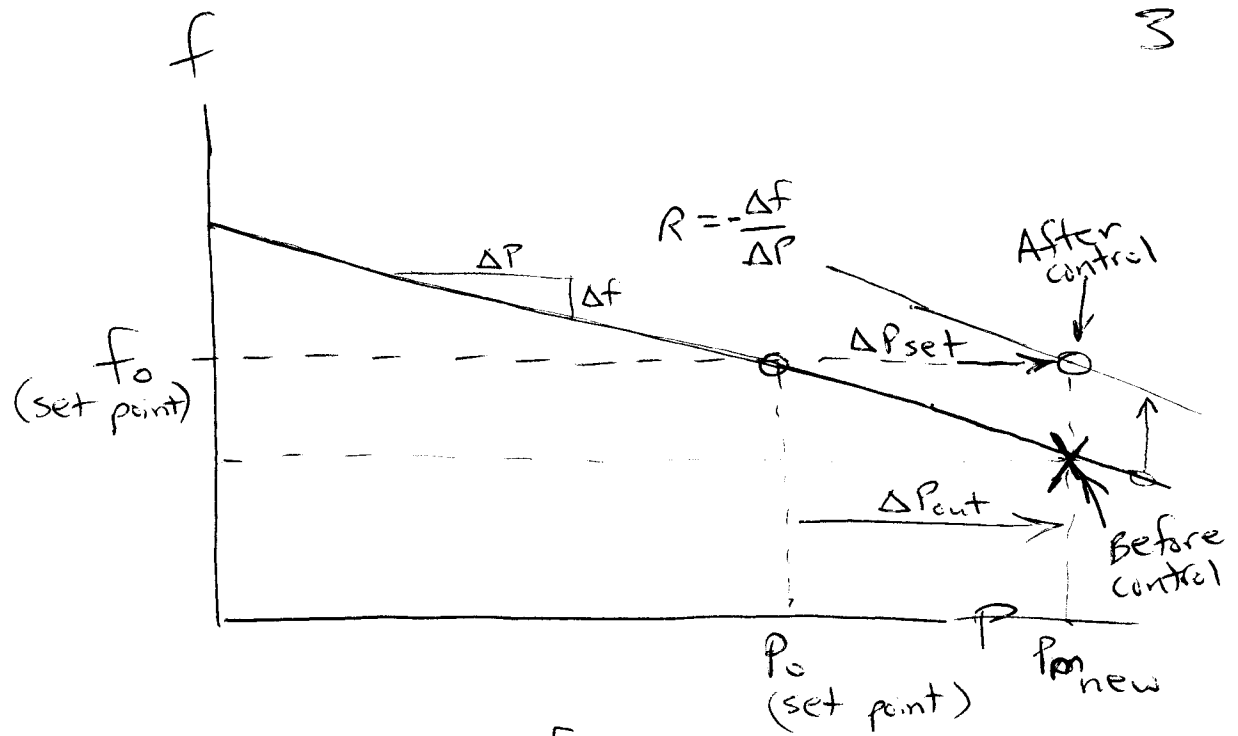

$R = -\text{slope of droop} = -\frac{\Delta f}{\Delta P}$, R always positive

= Droop, Regulation, Regulation Constant
Typically f & P are in per unit, as, then, is R .

$P_m = P_0$ is equilibrium set point. If P_m increases, f decreases. ($\Delta f = -R \Delta P$)

Governor must perform supplementary control of droop characteristic - it shifts it to a higher, but parallel position.

R values typically range from 3% — 6%.
Must keep all R 's in a system the same if all generators are to be loaded to same % of capacity. (R 's on each machine's base),

Typical $R = 5\%$ or 0.05 p.u.

For units in parallel, Δf is the same for a given system load change, provided no set points are changed.

$$\therefore R_1 \Delta P_1 = R_2 \Delta P_2 = \dots = R_n \Delta P_n = -\Delta f$$

$$\Delta P_{m_{sys}} = \Delta P_{sys} = \Delta P_1 + \Delta P_2 + \Delta P_3 + \dots + \Delta P_n$$

ΔP 's must be on same base!

R 's must be on same base!

$$R_{new} = R_{old} \frac{S_{base, new}}{S_{base, old}}$$



recall $R = -\frac{\Delta f}{\Delta P}$

$$\Delta P_{m_{sys}} = \underbrace{\left(\Delta P_{o,1} + \Delta P_{o,2} + \dots + \Delta P_{o,n} \right)}_{\substack{\text{Total Change in set points} \\ \text{at all generators}}} - \left(\frac{1}{R_1} + \frac{1}{R_2} + \dots + \frac{1}{R_n} \right) \Delta f$$

From Load Freq Control

If set points aren't changed,

$$\Delta P_{m_{sys}} = - \left(\frac{1}{R_1} + \frac{1}{R_2} + \dots + \frac{1}{R_n} \right) \Delta f = -\beta \Delta f$$

β = area freq response characteristic.
 (sort of like $\frac{1}{R_{EQ}}$) Adjust for:
 - system losses
 - freq-dep loads.

$$\therefore \Delta f = -\frac{\Delta P_m}{\beta} \text{ p.u. } (\times f_{synch} \text{ (or } f_0) \text{ to get Hz)}$$

once Δf is known, ΔP_m for individual machines can be found.

ex: $\Delta P_{m1} = -\frac{\Delta f}{R_1}$ Keep on same base

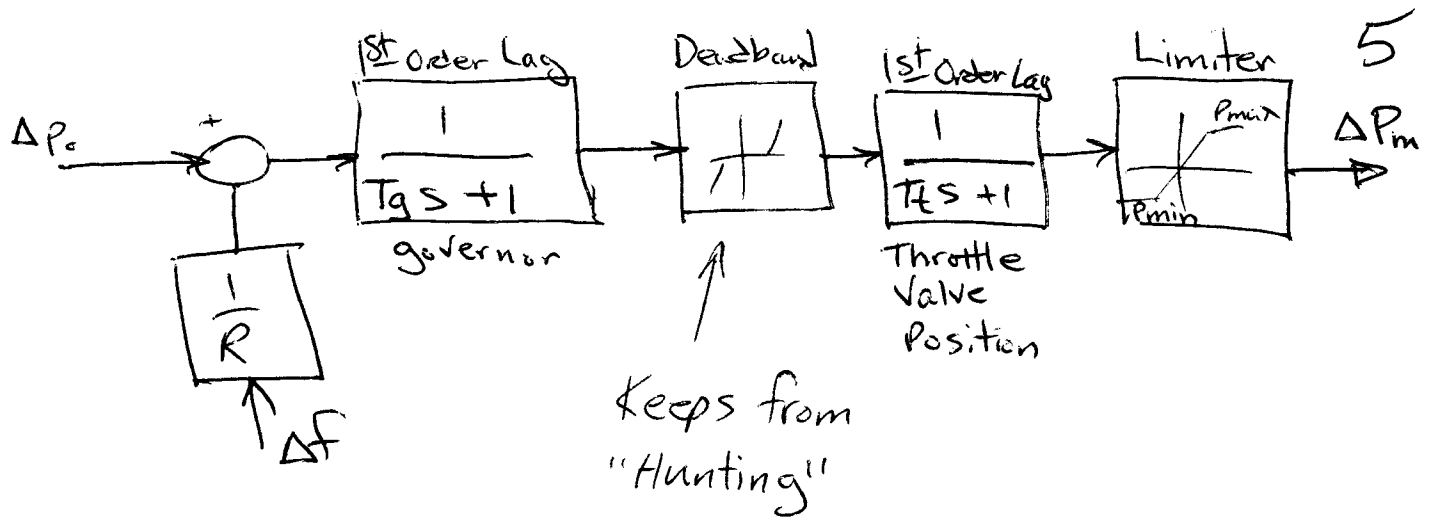

For dynamic real-time control, incorporate this into feedback control scheme.

Typical values: $T_g = 0.10 \text{ sec}$ (gov)
 $T_t = 1.00 \text{ sec}$ (throttle valve)

$\therefore \Delta P_m$ does not change appreciably in first 1.0 sec after frequency changes. That's why we neglect this in transient stability studies.

In addition, inertial response of turb/gen set must be considered. Its time constant T_a is on the order of 6-10 seconds.
 (Kundur, p. 598-599)

LOAD FREQUENCY CONTROL (LFC)

Area Control - must return Δf to zero after system load changes.

- Criteria -
- 1) Each area must do its part to return Δf to zero.
 - 2) Each area must maintain scheduled tie-line power flows

$$ACE = (P_{tie} - P_{tiesched}) + B_f (f - 60) \quad \left(\begin{array}{l} +\Delta P_D \\ \text{load change not due to freq.} \end{array} \right)$$

$$ACE = \Delta P_{tie} + B_f \Delta f$$

Objective: Drive ACE to zero.

ΔP_{tie} = error in tie-line flow
 $B_f \Delta f$ = error due to freq (compensation)

B_f = frequency bias constant (often set = β)

ΔP_o for each governor (change in reference setting)

$$\Delta P_{o,i} = -K_i \int ACE dt$$

K_i = integrator gain

Low freq or not enough tie line flow \Rightarrow neg ACE.

Integral ~~the~~ gives pos ΔP_o , meaning P_o will increase, and area's generation will increase.

Distributed process control via SCADA allocates a portion of ACE to each generator. ΔP_o raise/lower commands sent out every 1-2 secs from dispatch center.

Ex: Area 1: 2000 MW of gen
 $\beta_1 = 700$ MW/Hz
 Area 2: 4000 MW of gen
 $\beta_2 = 1400$ MW/Hz

Initially: $\Delta P_{tie1} = \Delta P_{tie2} = 0$ $f = 60$ Hz
 $\uparrow \quad \uparrow$ change in flow out of area.
Load in area 1 suddenly increases by 100 MW.

- Find Δf & ΔP_{tie} (steady-state error)

a) Without LFC Δf same for both systems

$$(\Delta P_{m1} + \Delta P_{m2}) = (\Delta P_{o1} + \Delta P_{o2}) - (\beta_1 + \beta_2) \Delta f$$

$$100 = -(\beta_1 + \beta_2) \Delta f \Rightarrow \Delta f = \frac{100}{2100} = -0.0476 \text{ Hz}$$

$$\Delta P_{m1} = -\beta_1 \Delta f = (-700)(-0.0476) = 33.3 \text{ MW}$$

$$\Delta P_{m2} = -\beta_2 \Delta f = (-1400)(-0.0476) = 66.7 \text{ MW}$$

$$\therefore \Delta P_{tie2} = 66.7 \text{ MW}$$

$$\Delta P_{tie1} = -66.7 \text{ MW}$$

b) With LFC, ACE driven to zero by changing P_o in each area.
 Area 1 - increase 100 MW.
 \therefore Area 2 - no change

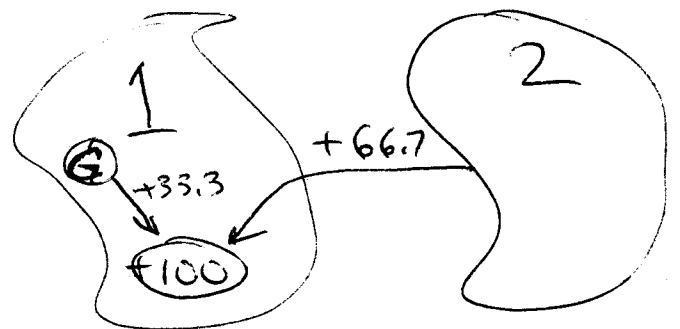

$$\begin{cases} ACE_1 = \Delta P_{tie1} + \beta_1 \Delta f = -66.7 - 33.3 \\ \quad \quad \quad = -100 \text{ MW} \\ ACE_2 = \Delta P_{tie2} + \beta_2 \Delta f = 66.7 - 66.7 \text{ MW} \end{cases}$$

From Gross, p. 508, ACE must also include error in desired tie line flow.

$\frac{1}{R}$ is actually = area β

ΔP_D = Change in load (non-free-dep part)

B = Frequency bias constant, used to calculate correct ACE from Δf .

B often set = β . (page 447 of Glover).

K_i = integrator ~~constant~~ ^{gain} - careful ^{not} to set too high

$$\Delta P_{12} = T_{12} (\delta_1 - \delta_2)$$

$$ACE = \Delta P_{tie} + B \Delta f = 0 \text{ if } \text{LFC enabled (in steady-state)}$$

13.6 AUTOMATIC GENERATION CONTROL

Almost all generating companies have tie-line interconnections to neighboring utilities. The lines allow the sharing of generation resources in emergencies and economies of power production under normal conditions of operation. For purposes of control the entire interconnected system is subdivided into *control areas* which usually conform to the boundaries of one or more companies. The *net interchange* of power over the tie lines of an area is the algebraic difference between area generation and area load (plus losses). A schedule is prearranged with neighboring areas for such tie-line flows, and as long as an area maintains the interchange power on schedule, it is evidently fulfilling its primary responsibility to absorb its own load changes. But since each area shares in the benefits of interconnected operation, it is expected also to share in the responsibility to maintain system frequency.

Frequency changes occur because system load varies randomly throughout the day so that an exact forecast of real power demand cannot be assured. The imbalance between real power generation and load demand (plus losses) throughout the daily load cycle causes kinetic energy of rotation to be either added to or taken from the on-line generating units, and frequency throughout the interconnected system varies as a result. Each control area has a central facility called the *energy control center*, which monitors the system frequency and the actual power flows on its tie lines to neighboring areas. The deviation between desired and actual system frequency is then combined with the deviation from the scheduled net interchange to form a composite measure called the *area control error*, or simply ACE. To remove area control error, the energy control center sends command signals to the generating units at the power plants within its area to control the generator outputs so as to restore the net interchange power to scheduled values and to assist in restoring the system frequency to its desired value. The monitoring, telemetering, processing, and control functions are coordinated within the individual area by the computer-based automatic generation control (AGC) system at the energy control center.

To help understand the control actions at the power plants, let us first consider the boiler-turbine-generator combination of a thermal generating unit. Most steam turbine-generators (and also hydroturbines) now in service are equipped with *turbine speed governors*. The function of the speed governor is to monitor continuously the turbine-generator speed and to control the throttle valves which adjust steam flow into the turbine (or the gate position in hydroturbines) in response to changes in "system speed" or frequency. We use *speed* and *frequency* interchangeably since they describe proportional quantities. To permit parallel operation of generating units, the speed-versus-power output governing characteristic of each unit has droop, which means that a decrease in speed should accompany an increase in load, as depicted by the straight line of Fig. 13.7(a). The *per-unit droop* or *speed regulation* R_u of the generating unit is defined as the magnitude of the change in steady-state speed, expressed in per unit of rated speed, when the output of the unit is gradually reduced from 1.00 per-unit rated power to zero. Thus, per-unit regulation is

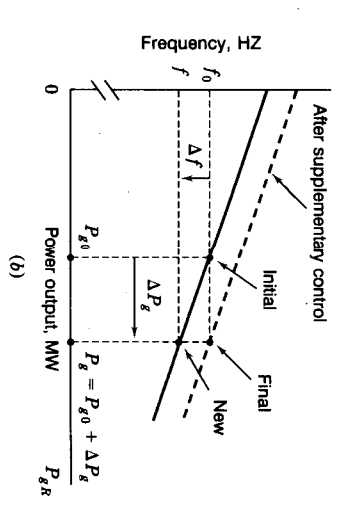
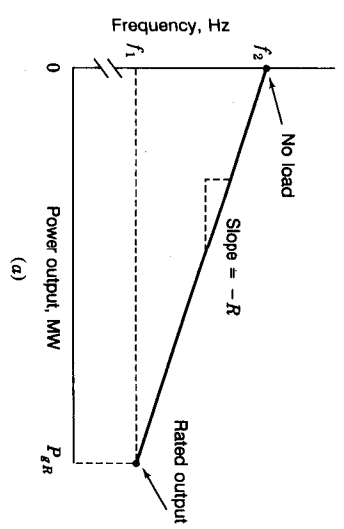

FIGURE 13.7
(a) Speed-governing characteristic of a generating unit; (b) before/after load increase ΔP_g and supplementary control.

simply the magnitude of the slope of the speed-versus-power output characteristic when the frequency axis and the power-output axis are each scaled in per unit of their respective rated values.

From Fig. 13.7(a) it follows that per-unit regulation is given by

$$R_u = \frac{(f_2 - f_1)/f_R}{P_{gR}/S_R} \text{ per unit} \tag{13.59}$$

where f_2 = frequency (in Hz) at no load
 f_1 = frequency (in Hz) at rated megawatt output P_{gR}
 f_R = rated frequency (in Hz) of the unit
 S_R = megawatt base

Multiplying each side of Eq. (13.59) by f_R/S_R gives

$$R = R_u \frac{f_R}{S_R} = \frac{f_2 - f_1}{P_{gR}} \text{ Hz/MW} \tag{13.60}$$

where R is the magnitude of the slope of the speed-droop characteristic (in Hz/MW). Suppose that the unit is supplying output power P_{g0} at frequency f_0 when the load is increased to $P_g = P_{g0} + \Delta P_g$, as shown in Fig. 13.7(b). As the speed of the unit decreases, the speed governor allows more steam from the boiler (or water from the gates) through to the turbine to arrest the decline in speed. Equilibrium between input and output power occurs at the new frequency $f = (f_0 + \Delta f)$ as shown. According to the slope of the speed-output characteristic given by Eq. (13.60), the frequency change (in Hz) is

$$\Delta f = -R \Delta P_g = -\left(R_{Ri} \frac{f_R}{S_{Ri}} \right) \Delta P_g \text{ Hz} \quad (13.61)$$

The isolated unit of Fig. 13.7 would continue to operate at the reduced frequency f except for the *supplementary control* action of the *speed changer*. The speed control mechanism has a speed changer motor which can parallel-shift the regulation characteristic to the new position shown by the dashed line of Fig. 13.7(b). Effectively, the speed changer supplements the action of the governor by changing the speed setting to allow more prime-mover energy through to increase the kinetic energy of the generating unit so that it can again operate at the desired frequency f_0 while providing the new output P_g .

When K generating units are operating in parallel on the system, their speed-droop characteristics determine how load changes are apportioned among them in the steady state. Consider that the K units are synchronously operating at a given frequency when the load changes by ΔP megawatts. Because the units are interconnected by the transmission networks, they are required to operate at speeds corresponding to a common frequency. Accordingly, in the steady-state equilibrium after initial governor action all units will have changed in frequency by the same incremental amount Δf hertz. The corresponding changes in the outputs of the units are given by Eq. (13.61) as follows:

$$\text{Unit 1: } \Delta P_{g1} = -\frac{S_{R1}}{R_{1u}} \frac{\Delta f}{f_R} \text{ MW} \quad (13.62)$$

$$\text{Unit } i: \Delta P_{gi} = -\frac{S_{Ri}}{R_{iu}} \frac{\Delta f}{f_R} \text{ MW} \quad (13.63)$$

$$\text{Unit } K: \Delta P_{gK} = -\frac{S_{RK}}{R_{Ku}} \frac{\Delta f}{f_R} \text{ MW} \quad (13.64)$$

Adding these equations together gives the total change in output

$$\Delta P = -\left(\frac{S_{R1}}{R_{1u}} + \dots + \frac{S_{Ri}}{R_{iu}} + \dots + \frac{S_{RK}}{R_{Ku}} \right) \frac{\Delta f}{f_R} \quad (13.65)$$

from which the system frequency change is

$$\frac{\Delta f}{f_R} = -\frac{\Delta P}{\left(\frac{S_{R1}}{R_{1u}} + \dots + \frac{S_{Ri}}{R_{iu}} + \dots + \frac{S_{RK}}{R_{Ku}} \right)} \text{ per unit} \quad (13.66)$$

Substituting from Eq. (13.66) into Eq. (13.63), we find the *additional* output ΔP_{gi} of Unit i

$$\Delta P_{gi} = \frac{S_{Ri}/R_{iu}}{\left(\frac{S_{R1}}{R_{1u}} + \dots + \frac{S_{Ri}}{R_{iu}} + \dots + \frac{S_{RK}}{R_{Ku}} \right)} \Delta P \text{ MW} \quad (13.67)$$

which combines with the additional outputs of the other units to satisfy the load change ΔP of the system. The units would continue to operate in synchronism at the new system frequency except for the supplementary control exercised by the AGC system at the energy control center of the area in which the load change occurs. *Raise* or *lower* signals are sent to some or all the speed changers at the power plants of the particular area. Through such coordinated control of the set points of the speed governors it is possible to bring all the units of the system back to the desired frequency f_0 and to achieve any desired load division within the capabilities of the generating units.

Therefore, the governors on units of the interconnected system tend to maintain load-generation balance rather than a specific speed and the supplementary control of the AGC system within the individual control area functions so as to:

- Cause the area to absorb its own load changes,
- Provide the prearranged net interchange with neighbors,
- Ensure the desired economic dispatch output of each area plant, and
- Allow the area to do its share to maintain the desired system frequency.

The ACE is continuously recorded within the energy control center to show how well the individual area is accomplishing these tasks.

The block diagram of Fig. 13.8 indicates the flow of information in a computer controlling a particular area. The numbers enclosed by circles adjacent to the diagram identify positions on the diagram to simplify our discussion of the control operation. The larger circles on the diagram enclosing the

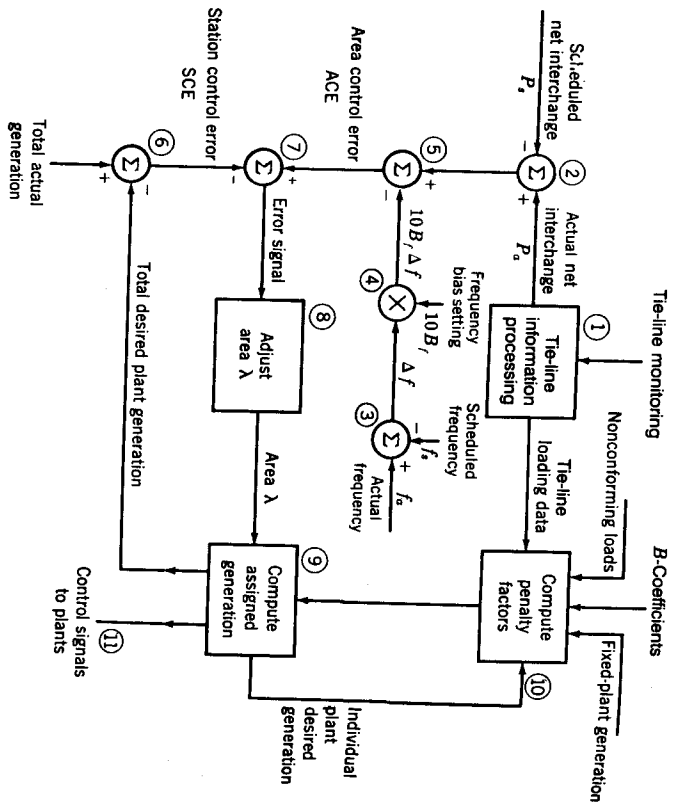

FIGURE 13.8
Block diagram illustrating the computer-controlled operation of a particular area.

symbols \times or Σ indicate points of multiplication or algebraic summation of incoming signals.

At position 1 processing of information about power flow on the lines to other control areas is indicated. The *actual* net interchange P_a is positive when net power is out of the area. The *scheduled* net interchange is P_s . At position 2 We shall discuss the condition where both actual and scheduled net interchange are out of the system and therefore positive.

Position 3 on the diagram indicates the subtraction of the scheduled frequency f_s (for instance, 60 Hz) from the actual frequency f_a to obtain Δf ,

³Subtraction of standard or reference value from actual value to obtain the error is the accepted convention of power system engineers and is the negative of the definition of control error found in the literature of control theory.

the frequency deviation. Position 4 on the diagram indicates that the frequency bias setting B_f , a factor with a *negative sign* and the units MW/0.1 Hz, is multiplied by $10 \Delta f$ to obtain a value of megawatts called the *frequency bias* ($10 B_f \Delta f$).

The frequency bias, which is positive when the actual frequency is less than the scheduled frequency, is subtracted from $(P_a - P_s)$ at position 5 to obtain the ACE, which may be positive or negative. As an equation

$$ACE = (P_a - P_s) - 10B_f(f_a - f_s) \text{ MW} \quad (13.68)$$

A negative ACE means that the area is not generating enough power to send the desired amount out of the area. There is a deficiency in net power output. Without frequency bias, the indicated deficiency would be less because there would be no positive offset ($10 B_f \Delta f$) added to P_s (subtracted from P_a) when the actual frequency is less than scheduled frequency and the ACE would be less. The area would produce sufficient generation to supply its own load and the rearranged interchange but would not provide the additional output to assist neighboring interconnected areas to raise the frequency.

Station control error (SCE) is the amount of actual generation of all the area plants minus the desired generation, as indicated at position 6 of the diagram. This SCE is negative when desired generation is greater than existing generation.

The key to the whole control operation is the comparison of ACE and SCE. Their difference is an error signal, as indicated at position 7 of the diagram. If both ACE and SCE are negative and equal, the deficiency in the output from the area equals the excess of the desired generation over the actual generation and no error signal is produced. However, this excess of desired generation will cause a signal, indicated at position 11, to go to the plants to increase their generation and to reduce the magnitude of the SCE; the resulting increase in output from the area will reduce the magnitude of the ACE at the same time.

If ACE is more negative than SCE, there will be an error signal to increase the λ of the area, and this increase will in turn cause the desired plant generation to increase (position 9). Each plant will receive a signal to increase its output as determined by the principles of economic dispatch.

This discussion has considered specifically only the case of scheduled net interchange out of the area (positive scheduled net interchange) that is greater than actual net interchange with ACE equal to or more negative than SCE. The reader should be able to extend the discussion to the other possibilities by referring to Fig. 13.8.

Position 10 on the diagram indicates the computation of penalty factors for each plant. Here the *B-coefficients* are stored to calculate $\partial P_c / \partial P_{gi}$ and the penalty factors. The penalty factors are transmitted to the section (position 9), which establishes the individual plant outputs for economic dispatch and the total desired plant generation.

One other point of importance (not indicated on Fig. 13.8) is the offset in scheduled net interchange of power that varies in proportion to the *time error*, which is the integral of the per-unit frequency error over time in seconds. The offset is in the direction to help in reducing the integrated difference to zero and thereby to keep electric clocks accurate.

Example 13.6. Two thermal generating units are operating in parallel at 60 Hz to supply a total load of 700 MW. Unit 1, with a rated output of 600 MW and 4% speed-droop characteristic, supplies 400 MW, and Unit 2, which has a rated output of 500 MW and 5% speed droop, supplies the remaining 300 MW of load. If the total load increases to 800 MW, determine the new loading of each unit and the common frequency change before any supplementary control action occurs. Neglect losses.

Solution. The initial point *a* of operation on the speed regulation characteristic of each unit is shown in Fig. 13.9. For the load increase of 100 MW, Eq. (13.66) gives the per-unit frequency deviation

$$\frac{\Delta f}{f_r} = \frac{-100}{\frac{600}{0.04} + \frac{500}{0.05}} = -0.004 \text{ per unit}$$

Since f_r equals 60 Hz, the frequency change is 0.24 Hz and the new frequency of operation is 59.76 Hz. The load change allocated to each unit is given by Eq. (13.67)

$$\Delta P_{r1} = \frac{600/0.04}{\frac{600}{0.04} + \frac{500}{0.05}} 100 = 60 \text{ MW}$$

$$\Delta P_{r2} = \frac{500/0.05}{\frac{600}{0.04} + \frac{500}{0.05}} 100 = 40 \text{ MW}$$

and so Unit 1 supplies 460 MW, whereas Unit 2 supplies 340 MW at the new operating points *b* shown in Fig. 13.9. If supplementary control were applied to Unit 1 alone, the entire 100-MW load increase could be absorbed by that unit by shifting its characteristic to the final 60-Hz position at point *c* of Fig. 13.9. Unit 2 would then automatically return to its original operating point to supply 300 MW at 60 Hz.

The large number of generators and governors within a control area combine to yield an aggregate governing speed-power characteristic for the area as a whole. For relatively small load changes this area characteristic is often assumed linear and then treated like that of a single unit of capacity equal to that of the prevailing on-line generation in the area. On this basis, the following

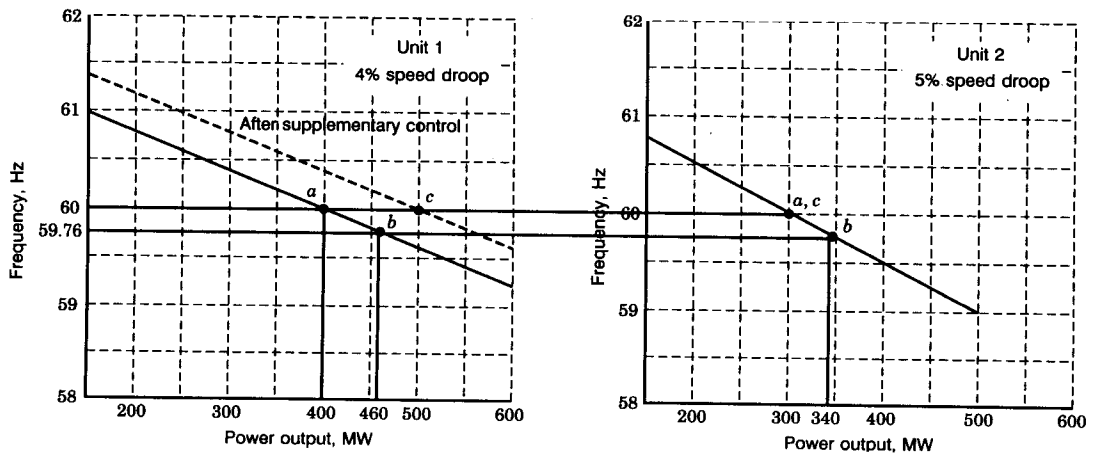

FIGURE 13.9 Load division between two isolated units of different speed-droop characteristics. Points *a* show initial distribution of 700-MW load; points *b* show distribution of 800-MW load at 59.76 Hz, and points *c* show final operating points of the units after supplementary control of Unit 1.

example demonstrates the steady-state operation of AGC for a three-area system in which losses are neglected.

Example 13.7. Three control areas with autonomous AGC systems comprise the interconnected 60-Hz system of Fig. 13.10(a). The aggregate speed-droop characteristics and on-line generating capacities of the areas are

- Area A: $R_{Aa} = 0.0200$ per unit; $S_{RA} = 16,000$ MW
- Area B: $R_{Ba} = 0.0125$ per unit; $S_{RB} = 12,000$ MW
- Area C: $R_{Ca} = 0.0100$ per unit; $S_{RC} = 6,400$ MW

Each area has a load level equal to 80% of its rated on-line capacity. For reasons of economy area C is importing 500 MW of its load requirements from area B, zero scheduled interchange of its own. Determine the system frequency deviation and the generation changes of each area when a fully loaded 400-MW generator is forced out of service in area B. The area frequency bias settings are

- $B_{fA} = -1200$ MW/0.1 Hz
- $B_{fB} = -1500$ MW/0.1 Hz
- $B_{fC} = -950$ MW/0.1 Hz

Determine the ACE of each area before AGC action begins.

Solution. The loss of the 400-MW unit is sensed by the other on-line generators as an increase in load, and so the system frequency decreases to a value determined by Eq. (13.66) as

$$\frac{\Delta f}{f_r} = \frac{-400}{\frac{16000}{0.0200} + \frac{12000}{0.0125} + \frac{6400}{0.0100}} = \frac{-10^{-3}}{6} \text{ per unit}$$

Therefore, the frequency decrease in 0.01 Hz after initial governor action and the generators still on-line increase their outputs according to Eq. (13.63), that is,

$$\begin{aligned} \Delta P_{gA} &= \frac{16000}{0.0200} \times \frac{10^{-3}}{6} = 133 \text{ MW} \\ \Delta P_{gB} &= \frac{12000}{0.0125} \times \frac{10^{-3}}{6} = 160 \text{ MW} \\ \Delta P_{gC} &= \frac{6400}{0.0100} \times \frac{10^{-3}}{6} = 107 \text{ MW} \end{aligned}$$

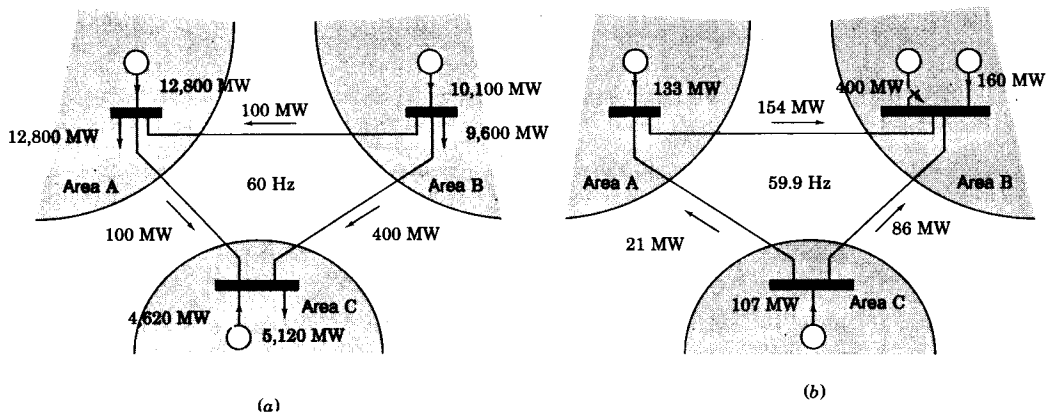

FIGURE 13.10 (a) Normal 60-Hz operation of three-area system of Example 13.9; (b) the incremental generation and tie-line flows resulting from the loss of 400-MW unit in area B before AGC action.

Let us suppose that these incremental changes are distributed to the interarea tie lines, as shown in Fig. 13.10(b). Then, by inspection, the area control error for each area may be written

$$\begin{aligned} (\text{ACE})_A &= (133 - 0) - 10(-1200)(-0.01) &= 13 \text{ MW} \\ (\text{ACE})_B &= (260 - 500) - 10(-1500)(-0.01) &= -390 \text{ MW} \\ (\text{ACE})_C &= [-393 - (-500)] - 10(-950)(-0.01) &= 12 \text{ MW} \end{aligned}$$

Ideally, the ACE in areas A and C would be zero. The predominating ACE is in area B where the 400-MW forced outage occurred. The AGC system of area B will command the on-line power plants under its control to increase generation to offset the loss of the 400-MW unit and to restore system frequency of 60 Hz. Areas A and C then return to their original conditions.

The frequency error in per unit equals the *time error* in seconds for every second over which the frequency error persists. Thus, if the per-unit frequency error of $(-10^{-3}/6)$ were to last for 10 min, then the *system time* (as given by an electric clock) would be 0.1 s slower than independent *standard time*.

13.7 UNIT COMMITMENT

Because the total load of the power system varies throughout the day and reaches a different peak value from one day to another, the electric utility has to decide in advance which generators to start up and when to connect them to the network—and the sequence in which the operating units should be shut down and for how long. The computational procedure for making such decisions is called *unit commitment*, and a unit when scheduled for connection to the system is said to be *committed*. Here we consider the commitment of fossil-fuel units which have different production costs because of their dissimilar efficiencies, designs, and fuel types. Although there are many other factors of practical significance which determine when units are scheduled on and off to satisfy the operating needs of the system, economics of operation is of major importance. Unlike on-line economic dispatch which economically distributes the *actual* system load as it arises to the various units already on-line, unit commitment plans for the best set of units to be available to supply the predicted or *forecast* load of the system over a future time period.

To develop the concept of unit commitment, we consider the problem of scheduling fossil-fired thermal units in which the aggregate costs (such as start-up costs, operating fuel costs, and shut-down costs) are to be minimized over a daily load cycle. The underlying principles are more easily explained if we disregard transmission loss in the system. Without losses, the transmission network is equivalent to a single plant bus to which all generators and all loads are connected, and the total plant output P_{gr} then equals the total system load P_D . We subdivide the 24-h day into discrete *intervals* or *stages* and the predicted

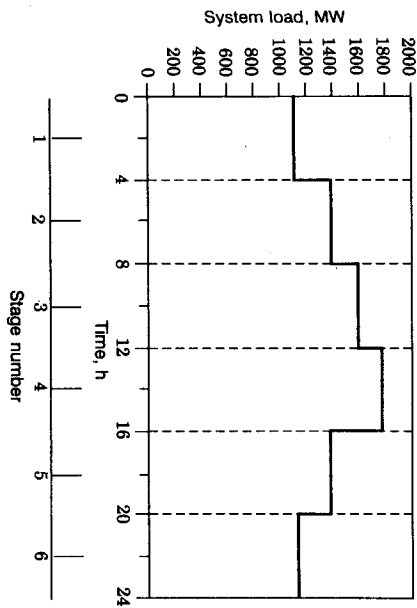

FIGURE 13.11 Discrete levels of system load for an example daily load cycle.

load of the system will be considered constant over each interval, as exemplified in Fig. 13.11. The unit commitment procedure then searches for the most economic *feasible combination* of generating units to serve the forecast load of the system at each stage of the load cycle.

The power system with K generating units (no two identical) must have at least one unit on-line to supply the system load which is never zero over the daily load cycle. If each unit can be considered either *on* (denoted by 1) or *off* (denoted by 0), there are $2^K - 1$ candidate combinations to be examined in each stage of the study period. For example, if $K = 4$, the 15 theoretically possible combinations for each interval are

Unit	Combinations														
	x_1	x_2	x_3	x_4	x_5	x_6	x_7	x_8	x_9	x_{10}	x_{11}	x_{12}	x_{13}	x_{14}	x_{15}
1	1	1	1	1	0	0	1	0	1	1	0	1	0	0	0
2	1	1	1	0	1	1	0	0	1	0	1	0	1	0	0
3	1	1	0	1	1	0	0	1	0	1	1	0	0	1	0
4	1	0	1	1	1	1	1	1	0	0	0	0	0	0	1

where x_i denotes combination i of the four units. Of course, not all combinations are feasible because of the constraints imposed by the load level and other practical operating requirements of the system. For example, a combination of units of total capability less than 1400 MW cannot serve a load of 1400 MW or greater; any such combination is *infeasible* and can be disregarded over any time